

**ONKYO®**

**AV Receiver**

# ***TX-SR804***

# ***TX-SR804E***

**Instruction Manual**

Thank you for purchasing an Onkyo AV Receiver.  
Please read this manual thoroughly before making  
connections and plugging in the unit.  
Following the instructions in this manual will enable  
you to obtain optimum performance and listening  
enjoyment from your new AV Receiver.  
Please retain this manual for future reference.

## **Contents**

**Introduction ..... 2**

**Connection ..... 19**

**Turning On & First Time Setup..... 39**

### **Basic Operation**

Playing your AV components ..... 48

Listening to the Radio ..... 49

**Enjoying the Listening Modes ..... 60**

**Advanced Operation ..... 64**

**Troubleshooting ..... 91**



## WARNING:

TO REDUCE THE RISK OF FIRE OR ELECTRIC SHOCK, DO NOT EXPOSE THIS APPARATUS TO RAIN OR MOISTURE.

## CAUTION:

TO REDUCE THE RISK OF ELECTRIC SHOCK, DO NOT REMOVE COVER (OR BACK). NO USER-SERVICEABLE PARTS INSIDE. REFER SERVICING TO QUALIFIED SERVICE PERSONNEL.



**WARNING**  
RISK OF ELECTRIC SHOCK  
DO NOT OPEN

**AVIS**  
RISQUE DE CHOC ELECTRIQUE  
NE PAS OUVRIR



The lightning flash with arrowhead symbol, within an equilateral triangle, is intended to alert the user to the presence of uninsulated “dangerous voltage” within the product’s enclosure that may be of sufficient magnitude to constitute a risk of electric shock to persons.



The exclamation point within an equilateral triangle is intended to alert the user to the presence of important operating and maintenance (servicing) instructions in the literature accompanying the appliance.

## Important Safety Instructions

1. Read these instructions.
2. Keep these instructions.
3. Heed all warnings.
4. Follow all instructions.
5. Do not use this apparatus near water.
6. Clean only with dry cloth.
7. Do not block any ventilation openings. Install in accordance with the manufacturer’s instructions.
8. Do not install near any heat sources such as radiators, heat registers, stoves, or other apparatus (including amplifiers) that produce heat.
9. Do not defeat the safety purpose of the polarized or grounding-type plug. A polarized plug has two blades with one wider than the other. A grounding type plug has two blades and a third grounding prong. The wide blade or the third prong are provided for your safety. If the provided plug does not fit into your outlet, consult an electrician for replacement of the obsolete outlet.
10. Protect the power cord from being walked on or pinched particularly at plugs, convenience receptacles, and the point where they exit from the apparatus.
11. Only use attachments/accessories specified by the manufacturer.
12. Use only with the cart, stand, tripod, bracket, or table specified by the manufacturer, or sold with the apparatus. When a cart is used, use caution when moving the cart/apparatus combination to avoid injury from tip-over.  
  
PORTABLE CART WARNING  
S3125A
13. Unplug this apparatus during lightning storms or when unused for long periods of time.
14. Refer all servicing to qualified service personnel. Servicing is required when the apparatus has been damaged in any way, such as power-supply cord or plug is damaged, liquid has been spilled or objects have fallen into the apparatus, the apparatus has been exposed to rain or moisture, does not operate normally, or has been dropped.
15. Damage Requiring Service  
Unplug the apparatus from the wall outlet and refer servicing to qualified service personnel under the following conditions:
  - A. When the power-supply cord or plug is damaged,
  - B. If liquid has been spilled, or objects have fallen into the apparatus,
  - C. If the apparatus has been exposed to rain or water,
  - D. If the apparatus does not operate normally by following the operating instructions. Adjust only those controls that are covered by the operating instructions as an improper adjustment of other controls may result in damage and will often require extensive work by a qualified technician to restore the apparatus to its normal operation,
  - E. If the apparatus has been dropped or damaged in any way, and
  - F. When the apparatus exhibits a distinct change in performance this indicates a need for service.
16. Object and Liquid Entry  
Never push objects of any kind into the apparatus through openings as they may touch dangerous voltage points or short-out parts that could result in a fire or electric shock.  
The apparatus shall not be exposed to dripping or splashing and no objects filled with liquids, such as vases shall be placed on the apparatus.  
Don’t put candles or other burning objects on top of this unit.
17. Batteries  
Always consider the environmental issues and follow local regulations when disposing of batteries.
18. If you install the apparatus in a built-in installation, such as a bookcase or rack, ensure that there is adequate ventilation.  
Leave 20 cm (8") of free space at the top and sides and 10 cm (4") at the rear. The rear edge of the shelf or board above the apparatus shall be set 10 cm (4") away from the rear panel or wall, creating a flue-like gap for warm air to escape.

# Precautions

1. **Recording Copyright**—Unless it's for personal use only, recording copyrighted material is illegal without the permission of the copyright holder.
2. **AC Fuse**—The AC fuse inside the unit is not user-serviceable. If you cannot turn on the unit, contact your Onkyo dealer.
3. **Care**—Occasionally you should dust the unit all over with a soft cloth. For stubborn stains, use a soft cloth dampened with a weak solution of mild detergent and water. Dry the unit immediately afterwards with a clean cloth. Don't use abrasive cloths, thinners, alcohol, or other chemical solvents, because they may damage the finish or remove the panel lettering.

## 4. Power WARNING

BEFORE PLUGGING IN THE UNIT FOR THE FIRST TIME, READ THE FOLLOWING SECTION CAREFULLY.

AC outlet voltages vary from country to country. Make sure that the voltage in your area meets the voltage requirements printed on the unit's rear panel (e.g., AC 230 V, 50 Hz or AC 120 V, 60 Hz).

The power cord plug is used to disconnect this unit from the AC power source. Make sure that the plug is readily operable (easily accessible) at all times.

Some models have a voltage selector switch for compatibility with power systems around the world. Before you plug in such a model, make sure that the voltage selector is set to the correct voltage for your area.

### For North American & Australian models

Setting the [STANDBY/ON] switch to STANDBY does not fully shutdown the unit. If you do not intend to use the unit for an extended period, remove the power cord from the AC outlet.

5. **Never Touch this Unit with Wet Hands**—Never handle this unit or its power cord while your hands are wet or damp. If water or any other liquid gets inside this unit, have it checked by your Onkyo dealer.
6. **Handling Notes**
  - If you need to transport this unit, use the original packaging to pack it how it was when you originally bought it.
  - Do not leave rubber or plastic items on this unit for a long time, because they may leave marks on the case.
  - This unit's top and rear panels may get warm after prolonged use. This is normal.
  - If you do not use this unit for a long time, it may not work properly the next time you turn it on, so be sure to use it occasionally.

## Memory Backup

The AV receiver uses a battery-less memory backup system in order to retain radio presets and other settings when it's unplugged or in the case of a power failure. Although no batteries are required, the AV receiver must be plugged into an AC outlet in order to charge the backup system. Once it has been charged, the AV receiver will retain the settings for several weeks, although this depends on the environment and will be shorter in humid climates.

## For British models

Replacement and mounting of an AC plug on the power supply cord of this unit should be performed only by qualified service personnel.

### IMPORTANT

The wires in the mains lead are coloured in accordance with the following code:

Blue: Neutral

Brown: Live

As the colours of the wires in the mains lead of this apparatus may not correspond with the coloured markings identifying the terminals in your plug, proceed as follows:



The wire which is coloured blue must be connected to the terminal which is marked with the letter N or coloured black.

The wire which is coloured brown must be connected to the terminal which is marked with the letter L or coloured red.

### IMPORTANT

The plug is fitted with an appropriate fuse. If the fuse needs to be replaced, the replacement fuse must be approved by ASTA or BSI to BS1362 and have the same ampere rating as that indicated on the plug. Check for the ASTA mark or the BSI mark on the body of the fuse. If the power cord's plug is not suitable for your socket outlets, cut it off and fit a suitable plug. Fit a suitable fuse in the plug.

## For European Models

|   |  |
|---|--|
| <b>Declaration of Conformity</b>  |  |
| We, ONKYO EUROPE<br>ELECTRONICS GmbH<br>LIEGNITZERSTRASSE 6,<br>82194 GROEBENZELL,<br>GERMANY   |               |
| declare in own responsibility, that the ONKYO product described in this instruction manual is in compliance with the corresponding technical standards such as EN60065, EN55013, EN55020 and EN61000-3-2, -3-3. |  |
| GROEBENZELL, GERMANY  | <br>K. MIYAGI |
| ONKYO EUROPE ELECTRONICS GmbH   |  |

## Precautions—Continued

---

### For U.S. models

#### FCC Information for User

##### CAUTION:

The user changes or modifications not expressly approved by the party responsible for compliance could void the user's authority to operate the equipment.

##### NOTE:

This equipment has been tested and found to comply with the limits for a Class B digital device, pursuant to Part 15 of the FCC Rules. These limits are designed to provide reasonable protection against harmful interference in a residential installation.

This equipment generates, uses and can radiate radio frequency energy and, if not installed and used in accordance with the instructions, may cause harmful interference to radio communications. However, there is no guarantee that interference will not occur in a particular installation. If this equipment does cause harmful interference to radio or television reception, which can be determined by turning the equipment off and on, the user is encouraged to try to correct the interference by one or more of the following measures:

- Reorient or relocate the receiving antenna.
- Increase the separation between the equipment and receiver.
- Connect the equipment into an outlet on a circuit different from that to which the receiver is connected.
- Consult the dealer or an experienced radio/TV technician for help.

### For Canadian Models

**NOTE:** THIS CLASS B DIGITAL APPARATUS COMPLIES WITH CANADIAN ICES-003.

For models having a power cord with a polarized plug:

**CAUTION:** TO PREVENT ELECTRIC SHOCK, MATCH WIDE BLADE OF PLUG TO WIDE SLOT, FULLY INSERT.

### Modèle canadien

**REMARQUE:** CET APPAREIL NUMÉRIQUE DE LA CLASSE B EST CONFORME À LA NORME NMB-003 DU CANADA.

Sur les modèles dont la fiche est polarisée:

**ATTENTION:** POUR ÉVITER LES CHOCS ÉLECTRIQUES, INTRODUIRE LA LAME LA PLUS LARGE DE LA FICHE DANS LA BORNE CORRESPONDANTE DE LA PRISE ET POUSSER JUSQU'AU FOND.

## Supplied Accessories

---

Make sure you have the following accessories:

---

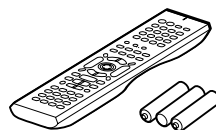

Remote controller and three batteries (AA/R6)

---

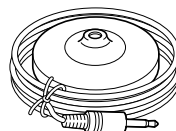

Speaker setup microphone

---



Indoor FM antenna

---

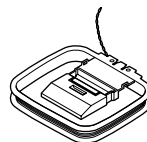

AM loop antenna

---

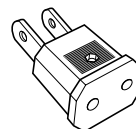

Power-plug adapter

Only supplied in certain countries. Use this adapter if your AC outlet does not match with the plug on the AV receiver's power cord. (Adapter varies from country to country.)

---

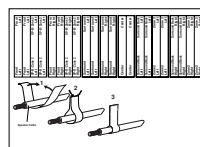

Speaker cable labels

---

- \* In catalogs and on packaging, the letter at the end of the product name indicates the color. Specifications and operation are the same regardless of color.

# Features

---

## Amplifier

---

- 7-channel amplifier
- 105 watts per channel into 8 ohms, 20 Hz to 20 kHz, less than 0.08% total harmonic distortion (FTC rating)
- Optimum Gain Volume Circuitry
- Zone 2 capability
- WRAT (Wide Range Amplifier Technology)
- Massive High Current Power Supply (H.C.P.S.) transformer
- Color-coded speaker terminal posts
- VLSC (Vector Linear Shaping Circuitry) on all channels

## Processing

---

- THX<sup>\*1</sup> Surround EX
- THX Select2<sup>\*1</sup> certified
- Dolby<sup>\*2</sup> Digital, Dolby Digital EX, Dolby Pro Logic IIx
- DTS<sup>\*3</sup>, DTS-ES Discrete, DTS-ES Matrix, DTS Neo:6, and DTS 96/24
- 24-bit/192 kHz D/A converters
- Powerful and highly accurate 32-bit DSP processing.
- Re-EQ<sup>\*4</sup> Function

## Audio/Video

---

- Powered Zone 2 and 12V trigger
- 2 HDMI<sup>\*6</sup> inputs, 1 output (Version 1.1)
- HDMI with upconversion of composite video, S-Video, and component video sources
- Composite video to S-Video and S-Video to composite video conversion
- 7 digital inputs (5 optical, 2 coaxial), 1 output (optical)
- 3 component video inputs, 1 output
- 5 S-Video inputs, 3 outputs
- RS-232 control
- Color-coded 7.1 multichannel input
- 7.1-channel pre out

## Tuner

---

- XM<sup>\*5</sup> Satellite Radio (North American only)  
\*XM Mini-Tuner and Home Dock required; sold separately.
- 40 AM/FM/XM presets
- AM/FM auto tuning
- RDS radio data (Europe only)

## Others

---

- Microphone for automatic speaker setup
- Easy-to-use onscreen setup menus
- IR IN and OUT
- Preprogrammed remote controller for use with other AV components
- Remote controller Learning function
- Remote controller Macro function

- \*1 THX and Select2 are trademarks of THX Ltd. THX may be registered in some jurisdictions. All rights reserved. Surround EX is a trademark of Dolby Laboratories. Used with permission.
- \*2 Manufactured under license from Dolby Laboratories. “Dolby”, “Pro Logic”, “Surround EX” and the double-D symbol are trademarks of Dolby Laboratories.
- \*3 “DTS”, “DTS 96/24”, “DTS-ES”, and “Neo:6” are trademarks of Digital Theater Systems, Inc.
- \*4 Re-Equalization and the “Re-EQ” logo are trademarks of THX Ltd.
- \*5 XM Ready<sup>®</sup> is trademark of XM Satellite Radio Inc. ©2006 XM Satellite Radio Inc. All rights reserved.
- \*6 HDMI, the HDMI logo and High Definition Multimedia Interface are trademarks or registered trademarks of HDMI Licensing, LLC.



### THX Select2

Before any home theater component can be THX Select2 certified, it must pass a rigorous series of quality and performance tests. Only then can a product feature the THX Select2 logo, which is your guarantee that the Home Theater products you purchase will give you superb performance for many years to come. THX Select2 requirements define hundreds of parameters, including power amplifier performance, and pre-amplifier performance and operation for both digital and analog domains. THX Select2 receivers also feature proprietary THX technologies (e.g., THX Mode) which accurately translate movie soundtracks for home theater playback.

- \* “Xantech” is a registered trademark of Xantech Corporation.
- \* “Niles” is a registered trademark of Niles Audio Corporation.
- \* Apple and iPod are trademarks of Apple Computer, Inc., registered in the U.S. and other countries.

This product incorporates copyright protection technology that is protected by U.S. patents and other intellectual property rights. Use of this copyright protection technology must be authorized by Macrovision Corporation, and is intended for home and other limited consumer uses only unless otherwise authorized by Macrovision. Reverse engineering or disassembly is prohibited.

# Multiroom Capability

**You can use two speaker systems with this AV receiver**—a surround-sound speaker system (up to 7.1 channels) in your main listening room and a stereo speaker system in your sub room, or Zone 2, as we call it—and you can enjoy a different audio source in each room.

**Main Room:** In your main listening room, you can enjoy up to 7.1-channel playback (see pages 20–21).

You can enjoy the various listening modes such as Dolby, DTS, and THX (pages 60–63).

\*If the Powered Zone 2 setting is set to Act, playback is reduced to 5.1-channels while Zone 2 is on (see page 83).

**Zone 2:** In your sub room, you can enjoy 2-channel stereo playback (pages 82–84).

\*The listening modes cannot be used with Zone 2.

\*Only analog input sources are output by Zone 2.

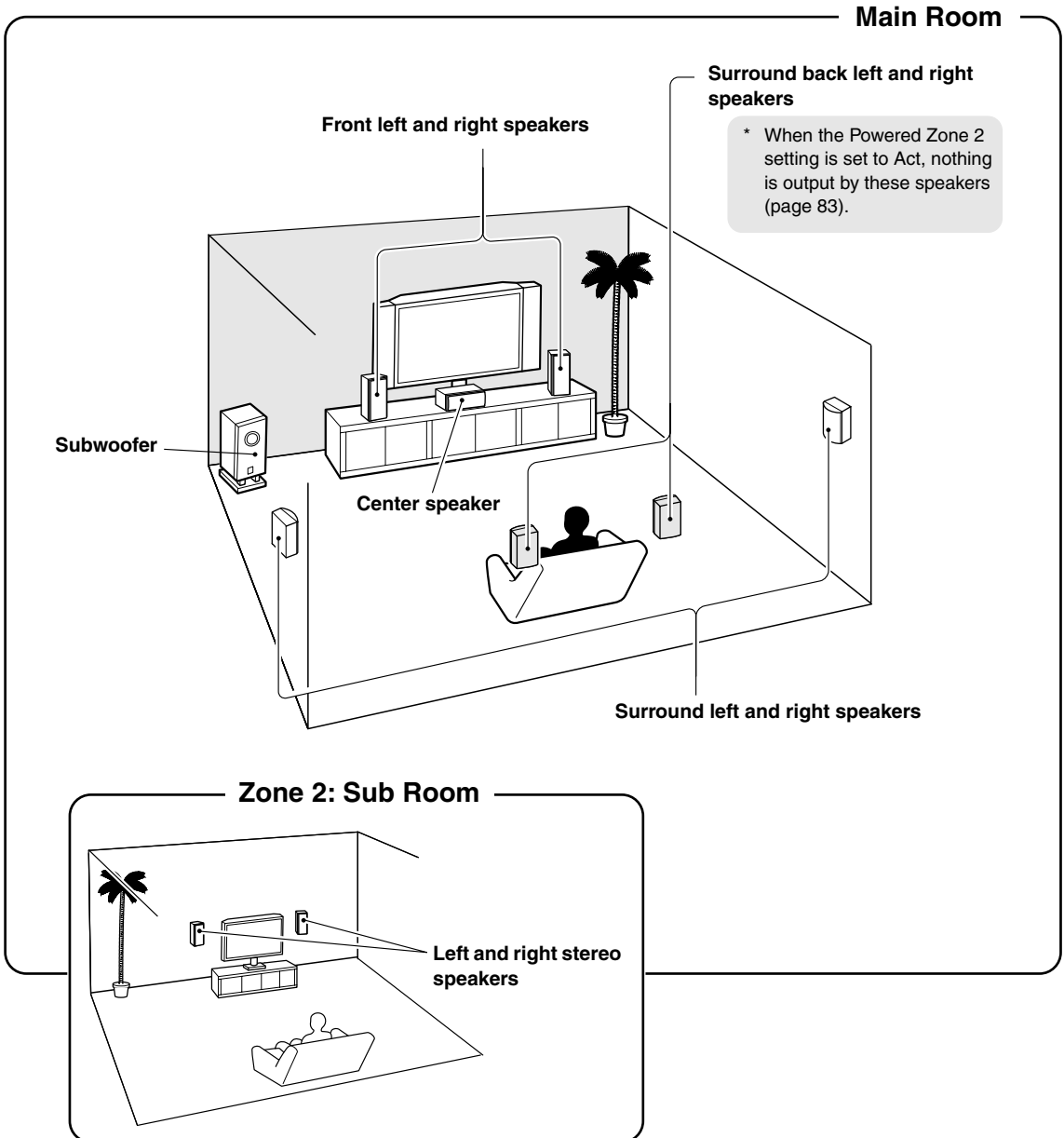

# Contents

## Introduction

|                                      |    |
|--------------------------------------|----|
| Important Safety Instructions .....  | 2  |
| Precautions .....                    | 3  |
| Supplied Accessories.....            | 4  |
| Features .....                       | 5  |
| Multiroom Capability .....           | 6  |
| Getting to Know the AV Receiver..... | 8  |
| Remote Controller.....               | 13 |

## Connection

|  |    |
|--|----|
| Connecting Your Speakers .....                                 | 19 |
| Connecting Antenna .....                                       | 22 |
| Connecting Your Components .....                               | 24 |
| About AV Connections .....                                     | 24 |
| Connecting Audio and Video Signals<br>to the AV Receiver ..... | 25 |
| Which Connections Should I Use? .....                          | 25 |
| TV or Projector .....  | 26 |
| DVD player .....   | 27 |
| VCR or DVD Recorder for Playback .....                         | 29 |
| VCR or DVD Recorder for Recording.....                         | 30 |
| Satellite, Cable, Set-top box,<br>or Other Video Source .....  | 31 |
| Components with HDMI .....                                     | 32 |
| Camcorder, Games Console,<br>or Other Device .....             | 34 |
| CD Player .....  | 35 |
| Turntable .....  | 35 |
| Cassette, CDR, MiniDisc,<br>or DAT Recorder.....               | 36 |
| Power Amplifier .....  | 36 |
| HDD-compatible Component .....                                 | 37 |
| Connecting the Power Cords of Other<br>Components.....         | 37 |
| Connecting Onkyo <b>RI</b> Components .....                    | 38 |
| Connecting the Power Cord .....                                | 38 |

## Turning On & First Time Setup

|   |    |
|---|----|
| Turning On the AV Receiver .....                    | 39 |
| Turning On and Standby .....                        | 39 |
| First Time Setup .....                              | 40 |
| Automatic Speaker Setup.....                        | 40 |
| HDMI Video Setup.....                               | 43 |
| Component Video Setup .....                         | 44 |
| Digital Audio Input Setup .....                     | 45 |
| Changing the Input Display .....                    | 46 |
| Minimum Speaker Impedance.....                      | 46 |
| TV Format Setup<br>(not North American models)..... | 47 |
| AM Frequency Step Setup<br>(on some models) .....   | 47 |

## Basic Operation

|  |    |
|--|----|
| Playing Your AV Components .....         | 48 |
| Listening to the Radio.....              | 49 |
| Listening to AM/FM Stations.....         | 49 |
| Listening to XM Satellite Radio®.....    | 52 |
| Presetting AM, FM, and XM Stations ..... | 56 |
| Using the Multichannel DVD Input.....    | 57 |
| Common Functions.....                    | 58 |
| Setting the Display Brightness.....      | 58 |
| Adjusting Speaker Levels .....           | 58 |
| Muting the AV Receiver .....             | 58 |
| Using the Sleep Timer .....              | 59 |
| Using Headphones .....                   | 59 |
| Displaying Source Information.....       | 59 |

## Enjoying the Listening Modes

|                                    |    |
|------------------------------------|----|
| Using the Listening Modes.....     | 60 |
| Selecting the Listening Modes..... | 60 |
| About the Listening Modes .....    | 62 |

## Advanced Operation

|   |    |
|---|----|
| Recording.....  | 64 |
| Onscreen Setup Menus .....  | 65 |
| Adjusting the Listening Modes .....                                       | 66 |
| Using the Re-EQ Function.....   | 66 |
| Audio Adjust Menu .....   | 66 |
| Default Listening Modes .....   | 69 |
| Advanced Setup .....  | 70 |
| Speaker Setup .....   | 70 |
| Input Setup .....   | 76 |
| Preferences .....   | 77 |
| Remote IDs.....   | 79 |
| Digital Input Signal Formats .....  | 80 |
| Correcting Sound and Picture Sync .....                                   | 81 |
| Zone 2.....   | 82 |
| Connecting Zone 2 .....   | 82 |
| Powered Zone 2 Setting .....  | 83 |
| Using Zone 2 .....  | 83 |
| Using the Remote Controller in Zone 2 and<br>Multiroom Control Kits ..... | 85 |
| Controlling Other Components.....   | 86 |
| Entering Remote Control Codes.....  | 86 |
| Resetting the Remote Controller .....                                     | 87 |
| Learning Commands from Other Remote<br>Controllers .....                  | 89 |
| Using Macros.....   | 90 |

|                       |    |
|-----------------------|----|
| Troubleshooting ..... | 91 |
| Specification .....   | 95 |

# Getting to Know the AV Receiver

## Front Panel

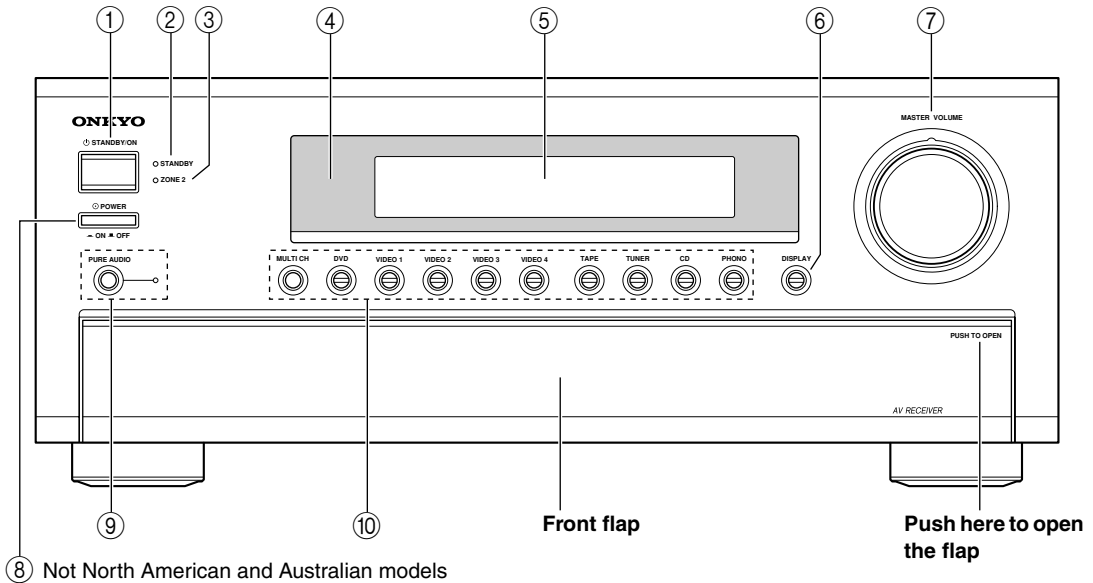

The actual front panel has various logos printed on it. They are not shown here for clarity. For detailed information, see the pages in parentheses.

- ① **STANDBY/ON button (39)**  
Sets the AV receiver to On or Standby.
- ② **STANDBY indicator (39)**  
Lights up when the AV receiver is on Standby and flashes while a signal is being received from the remote controller.
- ③ **ZONE 2 indicator (83)**  
Lights up when Zone 2 is on.
- ④ **Remote-control sensor (13)**  
Receives control signals from the remote controller.
- ⑤ **Display**  
See “Display” on page 10.
- ⑥ **DISPLAY button (59)**  
Displays various information about the currently selected input source.
- ⑦ **MASTER VOLUME control (48)**  
Sets the volume of the AV receiver to  $-\infty$  dB,  $-81$  dB,  $-80$  dB through  $+18$  dB (relative display).  
The volume level can also be displayed as an absolute value. See “Volume Setup” on page 77.
- ⑧ **POWER switch**  
American and Australian models don’t have this switch.  
This is the main power switch. When set to OFF, the AV receiver is completely shutdown. When set to ON, it’s in Standby mode and the STANDBY indicator lights up.
- ⑨ **PURE AUDIO button and indicator (60)**  
Selects the Pure Audio listening mode. The indicator lights up when this mode is selected. Pressing this button again selects the previous listening mode.
- ⑩ **Input selector buttons (48)**  
Select the following input sources: MULTI CH, DVD, VIDEO 1, VIDEO 2, VIDEO 3, VIDEO 4, TAPE, TUNER, CD, or PHONO.  
The [MULTI CH] button selects the multichannel DVD input.



## Getting to Know the AV Receiver—Continued

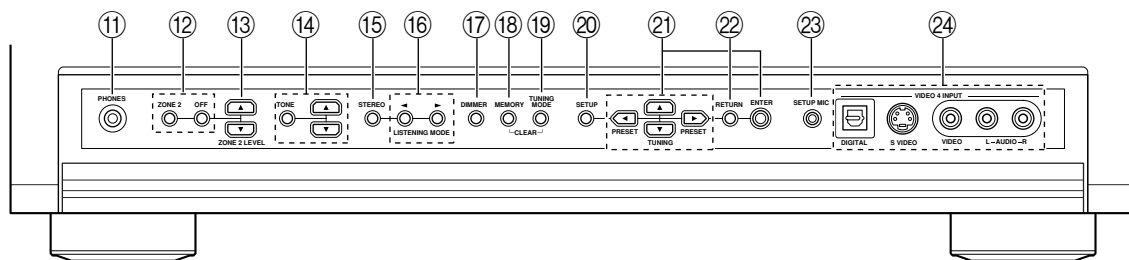

### On European Model

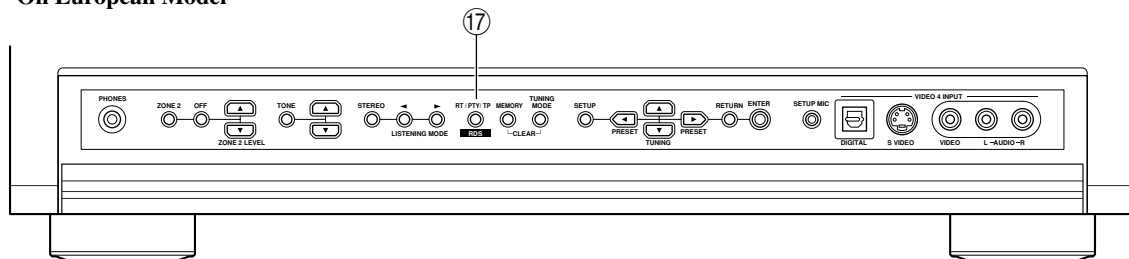

For detailed information, see the pages in parentheses.

- 11 PHONES jack (59)**  
This 1/4-inch phone jack is for connecting a standard pair of stereo headphones for private listening.
- 12 ZONE 2 and OFF buttons (83)**  
The ZONE 2 button is used to turn on Zone 2 and select the input source for Zone 2.  
The OFF button is used to turn off Zone 2.
- 13 ZONE 2 LEVEL buttons (84)**  
Set the volume of the Zone 2 speakers.
- 14 TONE, Up [▲], and Down [▼] buttons (67)**  
Used to adjust the bass and treble.
- 15 STEREO button (60)**  
Selects the Stereo listening mode.
- 16 LISTENING MODE [◀]/[▶] buttons (60)**  
Select the listening modes.
- 17 DIMMER (RT/PTY/TP) button (51, 58)**  
Adjusts the display brightness.  
On the European model, this is the RT/PTY/TP button, and it's used with RDS (Radio Data System). See "Using RDS (European Model Only)" on page 50.
- 18 MEMORY button (56)**  
Used when storing or deleting radio presets.
- 19 TUNING MODE button (49)**  
Selects the Auto or Manual tuning mode for AM and FM radio.
- 20 SETUP button**  
Opens and closes the onscreen setup menus, which are displayed on the connected TV.
- 21 Arrow/TUNING/PRESET and ENTER buttons**  
When AM, FM, or XM is selected, the TUNING [▲] [▼] buttons are used for radio tuning, and the PRESET [◀] [▶] buttons are used to select radio presets (see page 56). With the onscreen setup menus, they work as arrow buttons and are used to select and set items. The ENTER button is also used with the onscreen setup menus.
- 22 RETURN button**  
Selects the previously displayed onscreen setup menu.
- 23 SETUP MIC (40)**  
The automatic speaker setup microphone connects here.
- 24 VIDEO 4 INPUT (34, 64)**  
Used to connect a camcorder, game console, and so on. There are jacks for optical digital audio, S-Video, composite video, and analog audio.

### Display

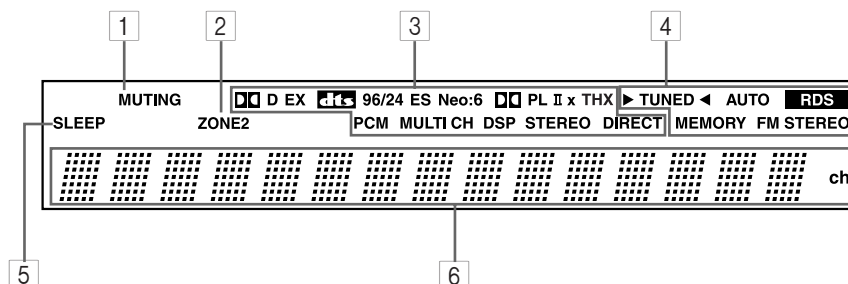

For detailed information, see the pages in parentheses.

- 1 **MUTING indicator (58)**  
Flashes while the AV receiver is muted.
- 2 **ZONE 2 indicator (83)**  
Lights up when Zone 2 is on.
- 3 **Listening mode and format indicators (60)**  
Show the selected listening mode and the format of digital input signals.
  - 4 **Tuning indicators (49)**
    - TUNED (49):** Lights up when tuned to a radio station.
    - AUTO (49):** For AM and FM radio, lights up when Auto Tuning mode is selected, and disappears when Manual Tuning mode is selected.
    - RDS (European model only) (50):** Lights up when tuned to a radio station that supports RDS (Radio Data System).
    - MEMORY (56):** Lights up when presetting radio stations.
    - FM STEREO (49):** Lights up when tuned to a stereo FM station.
- 5 **SLEEP indicator (59)**  
Lights up when the Sleep function has been set.
- 6 **Message area**  
Displays various information about the selected input source.

## Rear Panel

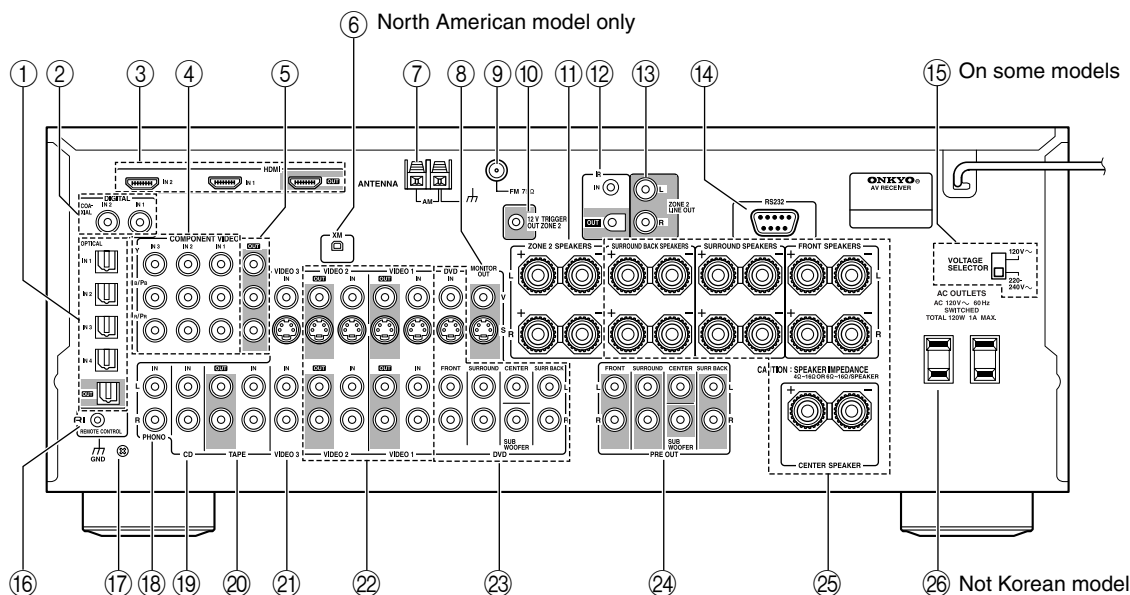

**① OPTICAL DIGITAL**

These optical digital audio inputs are for connecting components with optical digital audio outputs, such as CD players and DVD players.

The optical digital audio output is for connecting a digital recorder with an optical digital input, such as a CD recorder.

**② COAXIAL DIGITAL**

These coaxial digital audio inputs are for connecting components with coaxial digital audio outputs, such as CD players and DVD players.

**③ HDMI IN 1, 2, and OUT**

HDMI (High Definition Multimedia Interface) connections carry digital audio and digital video.

The HDMI inputs are for connecting components with HDMI outputs, such as DVD players.

The HDMI output is for connecting a TV or projector with an HDMI input.

**④ COMPONENT VIDEO IN 1, 2, and 3**

These RCA component video inputs are for connecting components with component video outputs, such as DVD players.

**⑤ COMPONENT VIDEO OUT**

This RCA component video output is for connecting a TV or projector with a component video input.

**⑥ XM antenna (on North American model)**

This jack is for connecting an XM digital antenna, sold separately.

**⑦ AM ANTENNA**

These push terminals are for connecting an AM antenna.

**⑧ MONITOR OUT**

The S-Video or composite video jack should be connected to a video input on your TV or projector.

**⑨ FM ANTENNA**

This jack is for connecting an FM antenna.

**⑩ 12V TRIGGER OUT ZONE 2**

This output can be connected to the 12-volt trigger input on a component in Zone 2. When Zone 2 is turned on on the AV receiver, a 12-volt trigger signal is output.

**⑪ ZONE 2 SPEAKERS**

These terminal posts are for connecting speakers in Zone 2.

**⑫ IR IN/OUT**

A commercially available IR receiver can be connected to the IR IN jack, allowing you to control the AV receiver while you're in Zone 2, or control it when it's out of sight, for example, installed in a cabinet.

A commercially available IR emitter can be connected to the IR OUT jack to pass IR (infrared) remote control signals along to other components.

**⑬ ZONE 2 LINE OUT**

This analog audio output can be connected to a line input on an amplifier in Zone 2.

### 14 **RS232**

This port is for connecting the AV receiver to home automation equipment and external controllers.

### 15 **VOLTAGE SELECTOR (on some models)**

Some models have a voltage selector switch for compatibility with power systems around the world.

Before you plug in such a model, make sure that the voltage selector is set to the correct voltage for your area. If it isn't, use a small screwdriver to select the correct setting. For example, if the voltage in your area is 120 volts, set the selector to "120 V." If it's between 220 and 240 volts, set it to "220-240 V."

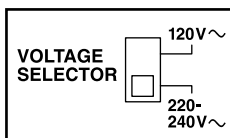

### 16 **RI REMOTE CONTROL**

This **RI** (Remote Interactive) jack can be connected to the **RI** jack on another **RI**-capable Onkyo component, for remote and system control.

To use **RI**, you must make an analog audio connection (RCA) between the AV receiver and the other component, even if they are connected digitally.

### 17 **GND screw**

This screw is for connecting a turntable's ground wire.

### 18 **PHONO IN**

This analog audio input is for connecting a turntable.

### 19 **CD IN**

This analog audio input is for connecting a CD player's analog audio output.

### 20 **TAPE IN/OUT**

This analog audio input and output are for connecting a recorder with an analog audio input and output, such as a cassette deck, MD recorder, etc.

### 21 **VIDEO 3 IN**

A VCR for playback only, or a cable or satellite receiver can be connected here. There's S-Video and composite video input jacks for connecting the video signal.

### 22 **VIDEO 1 IN/OUT and VIDEO 2 IN/OUT**

One or two video components can be connected here for recording and playback, such as a VCR. There's S-Video and composite video input and output jacks for connecting the video signal.

### 23 **DVD IN**

This input are for connecting a DVD player. There's S-Video and composite video input jacks for connecting the video signal, and stereo (FRONT) and multichannel 5.1/7.1 jacks for connecting the analog audio signals.

### 24 **PRE OUT FRONT L/R, SURROUND L/R, CENTER, SUBWOOFER, and SURR BACK L/R**

This 5.1/7.1 analog audio output can be connected to the analog audio input on another power amplifier, for when you want to use the AV receiver as a preamplifier. The SUBWOOFER jack is for connecting a powered subwoofer.

### 25 **FRONT, CENTER, SURROUND, and SURROUND BACK SPEAKERS**

These terminal posts are for connecting the front L/R, center, surround L/R, and surround back L/R speakers.

### 26 **AC OUTLETS**

These switched AC outlets can be used to supply power to other AV components. The type and number of outlets depends on the country in which you purchased your AV receiver.

# Remote Controller

## Installing the Batteries

- 1 To open the battery compartment, press the small hollow and slide open the cover.**

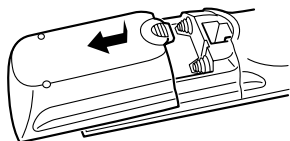

- 2 Insert the three supplied batteries (AA/R6) in accordance with the polarity diagram inside the battery compartment.**

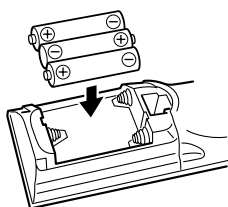

- 3 Slide the cover shut.**

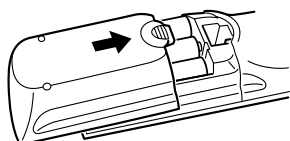

### Notes:

- If the remote controller doesn't work reliably, try replacing the batteries.
- Don't mix new and old batteries or different types of batteries.
- If you intend not to use the remote controller for a long time, remove the batteries to prevent damage from leakage or corrosion.
- Expired batteries should be removed as soon as possible to prevent damage from leakage or corrosion.

## Using the Remote Controller

To use the remote controller, point it at the AV receiver's remote control sensor, as shown below.

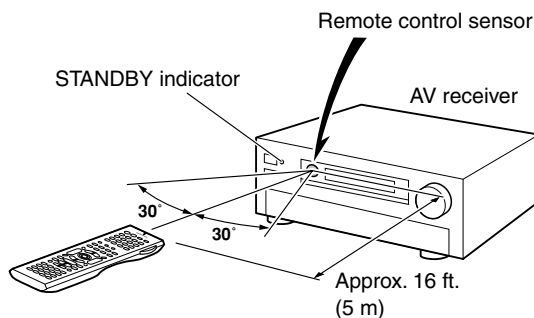

### Notes:

- The remote controller may not work reliably if the AV receiver is subjected to bright light, such as direct sunlight or inverter-type fluorescent lights. Keep this in mind when installing.
- If another remote controller of the same type is used in the same room, or the AV receiver is installed close to equipment that uses infrared rays, the remote controller may not work reliably.
- Don't put anything on top of the remote controller, such as a book or magazine, because a button may be pressed continuously, thereby draining the batteries.
- The remote controller may not work reliably if the AV receiver is installed in a rack behind colored glass doors. Keep this in mind when installing.
- The remote controller will not work if there's an obstacle between it and the AV receiver's remote control sensor.

## About the Remote Controller Modes

Including the AV receiver, the remote controller can be used to control up to nine different components. The remote controller has a specific operating mode for use with each type of component. Modes are selected by using the eight REMOTE MODE buttons.

### RECEIVER/TAPE Mode

In RECEIVER/TAPE mode, you can control the AV receiver and an Onkyo cassette recorder connected via **RI**.

### DVD Mode

By default, you can control an Onkyo DVD player in this mode. By entering the appropriate remote control code, you can control components made by other manufacturers (see page 86).

### CD Mode

By default, you can control an Onkyo CD player in this mode. By entering the appropriate remote control code, you can control a CD player, MD recorder, or CD recorder made by another manufacturer (see page 86).

### HDD Mode

This mode is for controlling Onkyo's next generation HDD-compatible components via **RI**.

### TV and VCR Modes

With these modes, you can control a TV and VCR. You must enter the appropriate remote control code first (see page 86).

### CABLE/CDR and SAT/MD Modes

In CABLE/CDR mode, you can control an Onkyo CD recorder or a cable TV receiver. In SAT/MD mode, you can control an Onkyo MD recorder or a satellite TV receiver. You must enter the appropriate remote control code first (see page 86).

**1 Use the REMOTE MODE buttons to select a mode.**

**2 Use the buttons supported by that mode to control the component.**

RECEIVER/TAPE mode: see page 14

DVD mode: see page 16

CD/MD/CDR modes: see page 17

HDD mode: see page 18

TV/VCR/SAT/CABLE modes: see page 88

## RECEIVER/TAPE Mode

RECEIVER/TAPE mode is used to control the AV receiver. It can also be used to control an Onkyo cassette recorder connected via **RI**.

**To set the remote controller to RECEIVER/TAPE mode, press the [RECEIVER] REMOTE MODE button.**

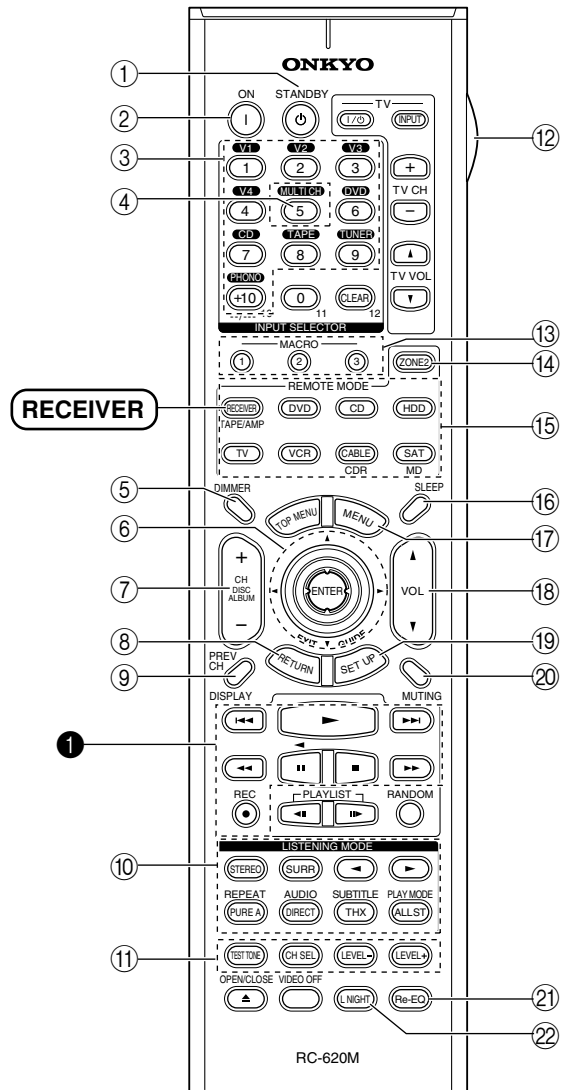

### Note:

Some of the remote controller operations described in this manual may not work as expected with other components.

## Remote Controller—Continued

For detailed information, see the pages in parentheses.

- ① **STANDBY button (39)**  
Sets the AV receiver to Standby.
- ② **ON button (39)**  
Turns on the AV receiver.
- ③ **INPUT SELECTOR buttons (48)**  
Used to select the input sources.
- ④ **MULTI CH button (57)**  
Selects the multichannel DVD input.
- ⑤ **DIMMER button (58)**  
Adjusts the display brightness.
- ⑥ **Arrow [▲]/[▼]/[◀]/[▶] and ENTER buttons**  
Used to select and adjust settings.
- ⑦ **CH +/- button (56)**  
Selects radio presets.
- ⑧ **RETURN button**  
Returns to the previous display when changing settings.
- ⑨ **DISPLAY button (59)**  
Displays various information about the currently selected input source.
- ⑩ **LISTENING MODE buttons (60)**  
Used to select the listening modes. The [STEREO], [SURR], and LISTENING MODE [◀]/[▶] buttons can be used regardless of the currently selected remote controller mode.
- ⑪ **TEST TONE, CH SEL, LEVEL-, and LEVEL+ buttons (58, 73)**  
Used to adjust the level of each speaker.
- ⑫ **LIGHT button**  
Turns the remote controller's illuminated buttons on or off.
- ⑬ **MACRO buttons (90)**  
Used with the Macro function.
- ⑭ **ZONE 2 button (84)**  
Used when setting the volume and input source for Zone 2.
- ⑮ **REMOTE MODE buttons (14)**  
Used to select the remote controller modes. When a remote controller button is pressed, the REMOTE MODE button of the currently selected mode lights up.
- ⑯ **SLEEP button (59)**  
Used with the Sleep function.
- ⑰ **MENU button (on North American model)**  
Selects the search mode for XM Satellite Radio.
- ⑱ **VOL [▲]/[▼] button (48)**  
Adjusts the volume of the AV receiver regardless of the currently selected remote controller mode.
- ⑲ **SETUP button**  
Used to change settings.

- ⑳ **MUTING button (58)**  
Mutes or unmutes the AV receiver.
- ㉑ **Re-EQ button (66)**  
Turns the Re-EQ function on or off.
- ㉒ **L NIGHT button (68)**  
Turns the Late Night function on or off.

### ■ TAPE mode

On twin cassette decks, only Deck B can be controlled.

#### ① **Previous and Next [◀◀]/[▶▶] buttons**

The Previous [◀◀] button selects the previous track. During playback it selects the beginning of the current track. The Next [▶▶] button selects the next track.

Depending on how they were recorded, the Previous and Next [◀◀]/[▶▶] buttons may not work properly with some cassette tapes.

#### **Play [▶] button**

Starts playback.

#### **Rewind and FF [◀◀]/[▶▶] buttons**

The Rewind [◀◀] button starts rewind. The FF [▶▶] button starts fast forward.

#### **Reverse Play [◀] button**

Starts reverse playback.

#### **Stop [■] button**

Stops playback.

#### **REC [●] button**

Starts recording.

## DVD Mode

To set the remote controller to DVD mode, press the [DVD] REMOTE MODE button.

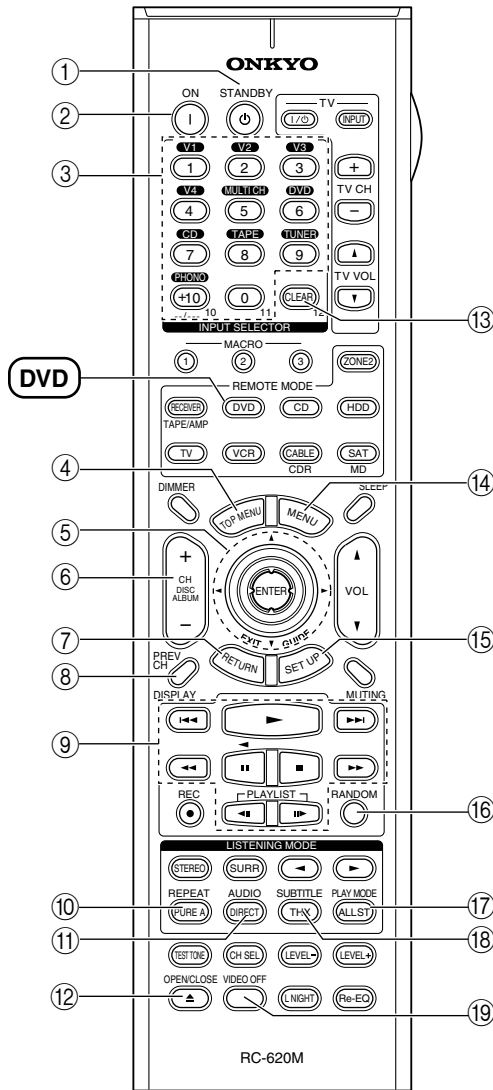

- ① **STANDBY button**  
Sets the DVD player to Standby.
- ② **ON button**  
Turns on the DVD player.
- ③ **Number buttons**  
Used to enter title, chapter, and track numbers, and to enter times for locating specific points.
- ④ **TOP MENU button**  
Selects a DVD's top menu.
- ⑤ **Arrow [▲]/[▼]/[◀]/[▶] and ENTER buttons**  
Used to navigate menus and select items.
- ⑥ **DISC +/- button**  
Selects discs on a DVD changer.
- ⑦ **RETURN button**  
Exits the DVD player's onscreen setup menu.
- ⑧ **DISPLAY button**  
Displays information about the current disc, title, chapter, or track, including elapsed time, remaining time, total time, and so on.
- ⑨ **Playback buttons**  
From left to right: Previous, Play, Next, Rewind, Pause, Stop, Fast Forward, Slow Reverse, and Slow Forward.
- ⑩ **REPEAT button**  
Used with the repeat playback function.
- ⑪ **AUDIO button**  
Selects foreign language soundtracks and audio formats (e.g., Dolby Digital or DTS).
- ⑫ **OPEN/CLOSE [▲] button**  
Opens and closes the disc tray.
- ⑬ **CLEAR button**  
Cancels functions and clears entered numbers.
- ⑭ **MENU button**  
Displays a DVD's menu.
- ⑮ **SETUP button**  
Used to access the DVD player's settings.
- ⑯ **RANDOM button**  
Used with the random playback function.
- ⑰ **PLAY MODE button**  
Selects play modes on components with selectable play modes.
- ⑱ **SUBTITLE button**  
Selects subtitles.
- ⑲ **VIDEO OFF button**  
Turns off the internal video circuitry, eliminating any possibility of interference.



## CD, MD, and CDR Modes

To control an Onkyo CD player or a CD/MD recorder made by another manufacturer, press the [CD] REMOTE MODE button to select the CD remote controller mode.

To control an Onkyo MD recorder or CD recorder, press the [MD] or [CDR] REMOTE MODE button to select the MD or CDR remote controller mode.

In order to control an Onkyo MD recorder or CD recorder, or a component made by another manufacturer, you must first enter the appropriate remote control code (see page 86).

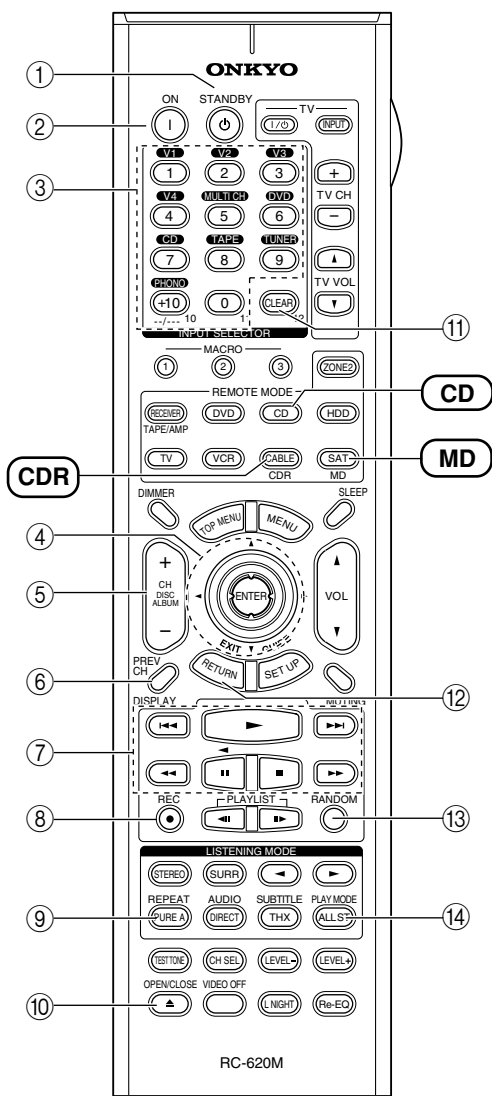

- ① **STANDBY button**  
Sets the CD player or MD/CD recorder to Standby.
- ② **ON button**  
Set the CD player or MD/CD recorder to On or Standby.
- ③ **Number buttons**  
Used to enter track numbers and times for locating specific points.
- ④ **Arrow [▲]/[▼]/[◀]/[▶] and ENTER buttons**  
Used with some components.
- ⑤ **DISC +/- button**  
Selects discs on a CD changer.
- ⑥ **DISPLAY button**  
Displays information about the current disc or track, including elapsed time, remaining time, total time, and so on.
- ⑦ **Playback buttons**  
From left to right: Previous, Play, Next, Rewind, Pause, Stop, and Fast Forward.
- ⑧ **REC [●] button**  
Starts recording.
- ⑨ **REPEAT button**  
Used with the repeat playback function.
- ⑩ **OPEN/CLOSE [▲] button**  
Opens and closes the disc tray or ejects the Mini-Disc.
- ⑪ **CLEAR button**  
Cancels functions and clears entered numbers.
- ⑫ **RETURN button**  
Used with some components.
- ⑬ **RANDOM button**  
Used with the random playback function.
- ⑭ **PLAY MODE button**  
Selects play modes on components with selectable play modes.

## HDD Mode

HDD mode is for controlling Onkyo's next generation HDD-compatible components. As of 2006, it can be used with the Onkyo RI Dock (Remote Interactive Dock) and Apple iPod connected via **RI**.

### When Using the RI Dock:

- Connect the RI Dock to the TAPE IN or VIDEO 3 IN jacks.
- Set the RI Dock's RI MODE switch to HDD.
- Set the AV receiver's Input Display to HDD (see page 46).
- Refer to the RI Dock's instruction manual.

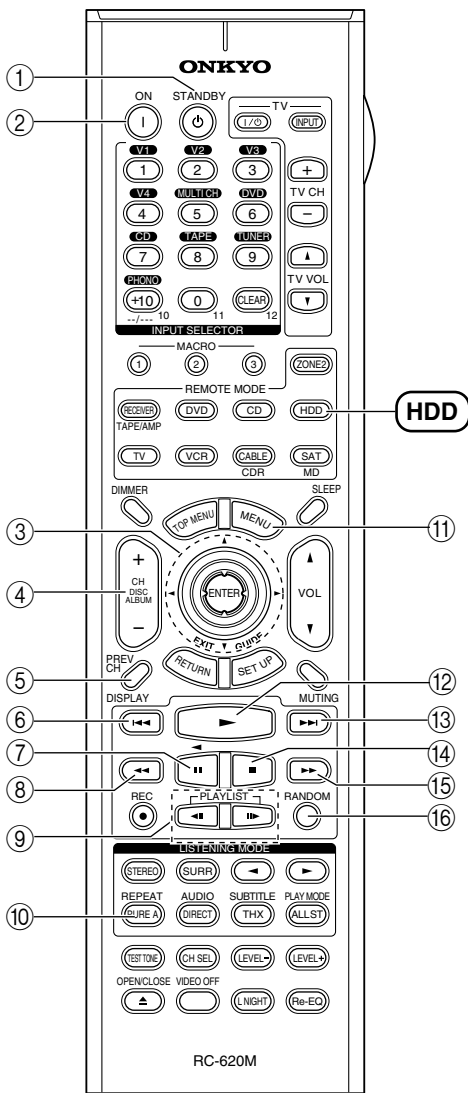

- 1 **STANDBY button**  
Turns off the HDD-compatible component.
- 2 **ON button\***  
Turns on the HDD-compatible component.
- 3 **Arrow [▲]/[▼] and ENTER buttons\***  
Used to navigate menus and select items.
- 4 **ALBUM +/- button\***  
Selects the next or previous album.
- 5 **DISPLAY button\***  
Turns on the backlight for 30 seconds.
- 6 **Previous [◀◀] button**  
Restarts the current song. Press it twice to select the previous song.
- 7 **Pause [||] button**  
Pauses playback. (With 3rd generation iPods, it works as a Play/Pause button.)
- 8 **Rewind [◀◀] button**  
Press and hold to rewind.
- 9 **PLAYLIST [◀◀]/[▶▶] buttons\***  
Used to select the previous or next playlist on the HDD-compatible component.
- 10 **REPEAT button\***  
Used with the repeat function.
- 11 **MENU button\***  
Used to access menus.
- 12 **Play [▶] button**  
Starts playback. If the component is off, it will turn on automatically. (With 3rd generation iPods, this button works as a Play/Pause button.)
- 13 **Next [▶▶] button**  
Selects the next song.
- 14 **Stop [■] button**  
Stops playback and displays a menu.
- 15 **Fast Forward [▶▶] button**  
Press and hold to fast forward.
- 16 **RANDOM button\***  
Used with the shuffle function.

\* Buttons marked with an asterisk (\*) are not supported by 3rd generation iPods.

# Connecting Your Speakers

## Enjoying Home Theater

Thanks to the AV receiver's superb capabilities, you can enjoy surround sound with a real sense of movement in your own home—just like being in a movie theater or concert hall. You can enjoy DVDs featuring DTS and Dolby Digital. With analog and digital TV, you can enjoy Dolby Pro Logic IIx and Onkyo's own DSP surround listening modes. You can also enjoy THX Surround EX (THX-certified THX speaker system recommended).

### Front left and right speakers

These output the overall sound. Their role in a home theater is to provide a solid anchor for the sound image. They should be positioned facing the listener at about ear level, and equally spaced from the TV. Angle them inward slightly so as to create a triangle, with the listener at the apex.

### Center speaker

This speaker enhances the front left and right speakers, making sound movements distinct and providing a full sound image. For movies it's used mainly for dialog.

Position it close to your TV (preferably on top) facing forward at about ear level, or at the same height as the front left and right speakers.

### Subwoofer

The subwoofer handles the bass sounds of the LFE (Low-Frequency Effects) channel. The volume and quality of the bass output from your subwoofer will depend on its position, the shape of your listening room, and your listening position. In general, a good bass sound can be obtained by installing the subwoofer in a front corner, or at one-third the way along the wall, as shown.

**Tip:** To find the best position for your subwoofer, while playing a movie or some music with good bass, experiment by placing your subwoofer at various positions within the room, and choose the one that provides the most satisfying results.

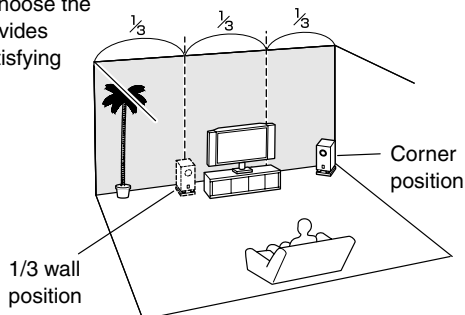

### Surround left and right speakers

These speakers are used for precise sound positioning and to add realistic ambience.

Position them at the sides of the listener, or slightly behind, about 2–3 feet (60–100 cm) above ear level. Ideally they should be equally spaced from the listener.

### Surround back left and right speakers

These speakers are necessary to enjoy Dolby Digital EX, DTS-ES Matrix, DTS-ES Discrete, THX Surround EX, etc. They enhance the realism of surround sound and improve sound localization behind the listener. Position them behind the listener about 2–3 feet (60–100 cm) above ear level.

THX recommends that they be placed as close as possible in order to make advantage of their proprietary ASA (Advanced Speaker Array) technology. If this condition is not possible, adjust the SurrBack Sp Spacing setting via the THX Audio Setup. (See page 74.)

## Connecting Your Speakers

### Speaker Configuration

For the best surround-sound experience, you should connect seven speakers and a powered subwoofer.

The following table shows which channels you should use based on the number of speakers you have.

| Number of speakers:  | 2 | 3 | 4 | 5 | 6 | 7 |
|----------------------|---|---|---|---|---|---|
| Front left           | ✓ | ✓ | ✓ | ✓ | ✓ | ✓ |
| Front right          | ✓ | ✓ | ✓ | ✓ | ✓ | ✓ |
| Center               |   | ✓ |   | ✓ | ✓ | ✓ |
| Surround left        |   |   | ✓ | ✓ | ✓ | ✓ |
| Surround right       |   |   | ✓ | ✓ | ✓ | ✓ |
| Surround back        |   |   |   |   | ✓ |   |
| Surround back left*  |   |   |   |   |   | ✓ |
| Surround back right* |   |   |   |   |   | ✓ |

\*If you're using only one surround back speaker, connect it to the left (L) SURROUND BACK SPEAKERS terminals.

No matter how many speakers you use, a powered subwoofer is recommended for a really powerful and solid bass.

To get the best from your surround-sound system, you need to set the speaker settings by using the supplied setup microphone (see page 40).

### Using Dipole Speakers

You can use dipole speakers for the surround left and right and surround back left and right speakers. Dipole speakers output the same sound in two directions.

Dipole speakers typically have an arrow printed on them to indicate how they should be positioned. The surround left and right dipole speakers should be positioned so that their arrows point toward the TV/screen, while the surround back left and right dipole speakers should be positioned so that their arrows point toward each other, as shown.

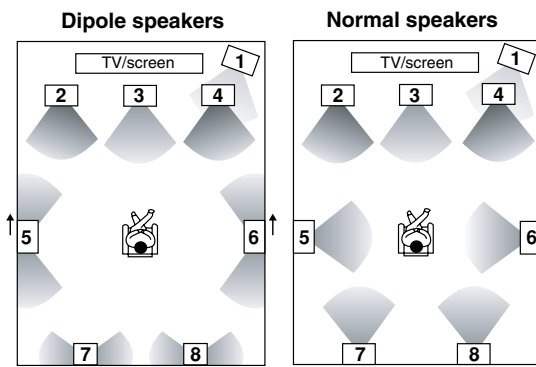

- 1. Subwoofer
- 2. Front left speaker
- 3. Center speaker
- 4. Front right speaker
- 5. Surround left speaker
- 6. Surround right speaker
- 7. Surround back left speaker
- 8. Surround back right speaker

### Connecting a Powered Subwoofer

Using a suitable cable, connect the AV receiver's SUBWOOFER PRE OUT to the input on your powered subwoofer. If your subwoofer is unpowered and you're using an external amplifier, connect the SUBWOOFER PRE OUT to the amp's input.

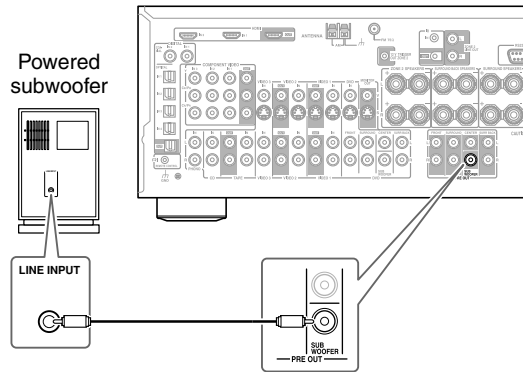

### Attaching the Speaker Labels

The AV receiver's positive (+) speaker terminals are color-coded for ease of identification. (The negative (-) speaker terminals are all black.)

| Speaker terminal          | Color |
|---------------------------|-------|
| Front left, Zone 2 left   | White |
| Front right, Zone 2 right | Red   |
| Center                    | Green |
| Surround left             | Blue  |
| Surround right            | Gray  |
| Surround back left        | Brown |
| Surround back right       | Tan   |

The supplied speaker labels are also color-coded and you should attach them to the positive (+) side of each speaker cable in accordance with the above table. All you need to do then is to match the color of each label to the corresponding speaker terminal.



## Connecting Your Speakers—Continued

### Speaker Connection Precautions

Read the following before connecting your speakers:

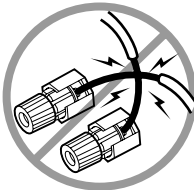
- You can connect speakers with an impedance of between 4 and 16 ohms. If the impedance of any of the connected speakers is 4 ohms or more but less than 6, be sure to set the minimum speaker impedance to 4 ohms (see page 46). If you use speakers with a lower impedance, and use the amplifier at high volume levels for a long period of time, the built-in amp protection circuit may be activated.
- Disconnect the power cord from the wall outlet before making any connections.
- Read the instructions supplied with your speakers.
- Pay close attention to speaker wiring polarity. In other words, connect positive (+) terminals to only positive (+) terminals, and negative (–) terminals to only negative (–) terminals. If you get them the wrong way around, the sound will be out of phase and will sound unnatural.
- Unnecessarily long or very thin speaker cables may affect the sound quality and should be avoided.
- Be careful not to short the positive and negative wires. Doing so may damage the AV receiver. 
- Don't connect more than one cable to each speaker terminal. Doing so may damage the AV receiver.
- Don't connect a speaker to several terminals.

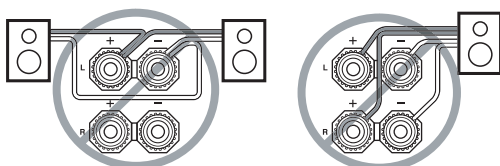

### Connecting the Speaker Cables

- 1 Strip about 5/8" (15 mm) of insulation from the ends of the speaker cables, and twist the bare wires tightly, as shown.**

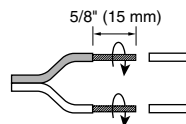

- 2 Unscrew the terminal.**



- 3 Fully insert the bare wires.**

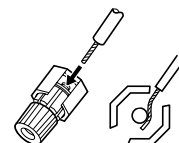

- 4 Screw the terminal tight.**

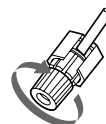

The following illustration shows which speaker should be connected to each pair of terminals.

If you're using only one surround back speaker, connect it to the left (L) SURROUND BACK SPEAKERS terminals.

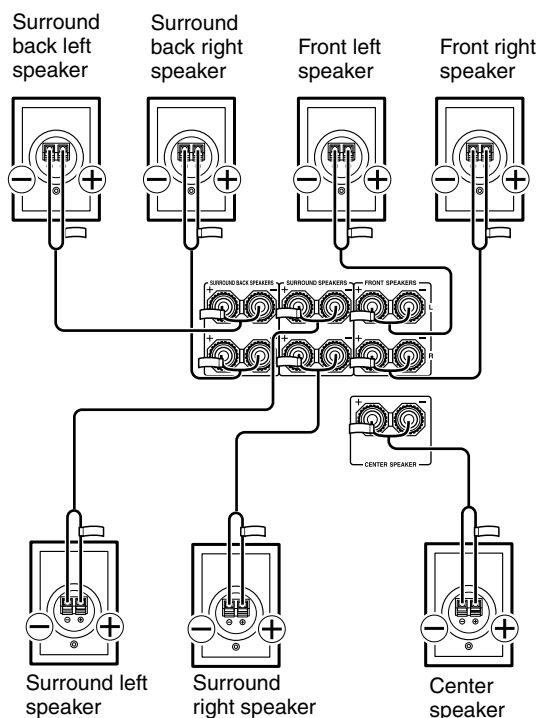

# Connecting Antenna

This section explains how to connect the supplied indoor FM antenna and AM loop antenna, and how to connect commercially available outdoor FM and AM antennas. The AV receiver won't pick up any radio signals without any antenna connected, so you must connect the antenna to use the tuner.

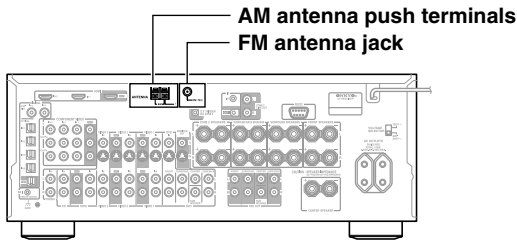

## Connecting the Indoor FM Antenna

The supplied indoor FM antenna is for indoor use only.

### 1 Attach the FM antenna, as shown.

#### ■ American Model

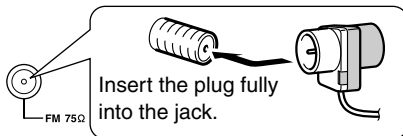

#### ■ Other Models

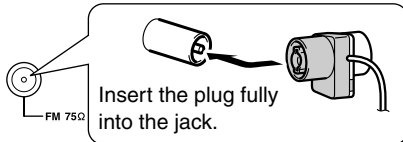

Once your AV receiver is ready for use, you'll need to tune into an FM radio station and adjust the position of the FM antenna to achieve the best possible reception.

### 2 Use thumbtacks or something similar to fix the FM antenna into position.

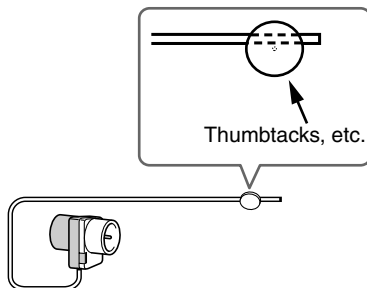

**Caution:** Be careful that you don't injure yourself when using thumbtacks.

If you cannot achieve good reception with the supplied indoor FM antenna, try a commercially available outdoor FM antenna instead (see page 23).

## Connecting the AM Loop Antenna

The supplied indoor AM loop antenna is for indoor use only.

### 1 Assemble the AM loop antenna, inserting the tabs into the base, as shown.

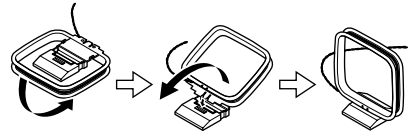

### 2 Connect both wires of the AM loop antenna to the AM push terminals, as shown.

(The antenna's wires are not polarity sensitive, so they can be connected either way around).

Make sure that the wires are attached securely and that the push terminals are gripping the bare wires, not the insulation.

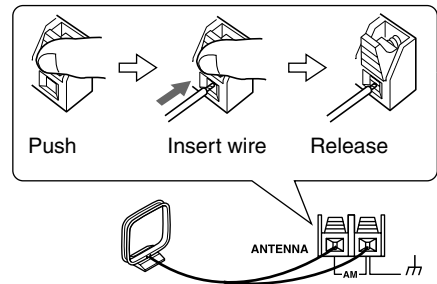

Once your AV receiver is ready for use, you'll need to tune into an AM radio station and adjust the position of the AM antenna to achieve the best possible reception.

Keep the antenna as far away as possible from your AV receiver, TV, speaker cables, and power cords.

If you cannot achieve good reception with the supplied indoor AM loop antenna, try using it with a commercially available outdoor AM antenna (see page 23).

### Connecting an Outdoor FM Antenna

If you cannot achieve good reception with the supplied indoor FM antenna, try a commercially available outdoor FM antenna instead.

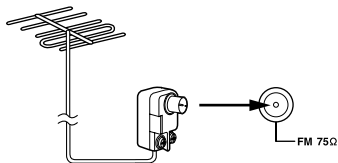

#### Notes:

- Outdoor FM antennas work best outside, but usable results can sometimes be obtained when installed in an attic or loft.
- For best results, install the outdoor FM antenna well away from tall buildings, preferably with a clear line of sight to your local FM transmitter.
- Outdoor antenna should be located away from possible noise sources, such as neon signs, busy roads, etc.
- For safety reasons, outdoor antenna should be situated well away from power lines and other high-voltage equipment.
- Outdoor antenna must be grounded in accordance with local regulations to prevent electrical shock hazards.

#### ■ Using a TV/FM Antenna Splitter

It's best not to use the same antenna for both FM and TV reception, as this can cause interference problems. If circumstances demand it, use a TV/FM antenna splitter, as shown.

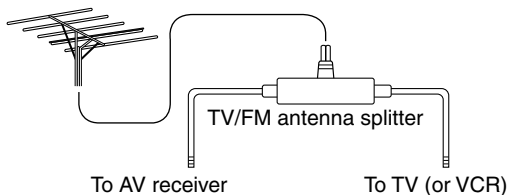

### Connecting an Outdoor AM Antenna

If good reception cannot be achieved using the supplied AM loop antenna, an outdoor AM antenna can be used in addition to the loop antenna, as shown.

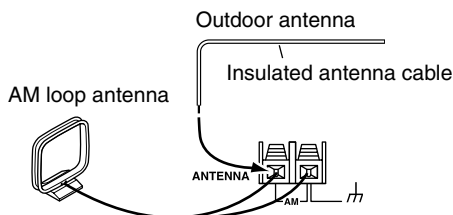

Outdoor AM antennas work best when installed horizontally outside, but good results can sometimes be obtained indoors by mounting horizontally above a window. Note that the AM loop antenna should be left connected. Outdoor antenna must be grounded in accordance with local regulations to prevent electrical shock hazards.

# Connecting Your Components

## About AV Connections

- Before making any AV connections, read the manuals supplied with your other AV components.
- Don't connect the power cord until you've completed and double-checked all AV connections.

## Optical Digital Jacks

The AV receiver's optical digital jacks have shutter-type covers that open when an optical plug is inserted and close when it's removed. Push plugs in all the way.

**Caution:** To prevent shutter damage, hold the optical plug straight when inserting and removing.

## AV Connection Color Coding

RCA-type AV connections are usually color coded: red, white, and yellow. Use red plugs to connect right-channel audio inputs and outputs (typically labeled "R"). Use white plugs to connect left-channel audio inputs and outputs (typically labeled "L"). And use yellow plugs to connect composite video inputs and outputs.

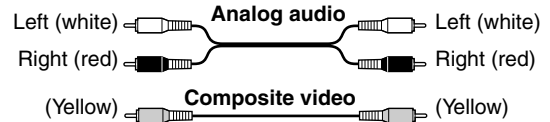

- Push plugs in all the way to make good connections (loose connections can cause noise or malfunctions).
- To prevent interference, keep audio and video cables away from power cords and speaker cables.

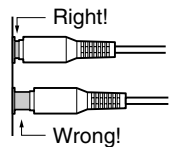

## AV Cables and Jacks

### Video

|                              | Cable | Jack | Description  |
|------------------------------|-------|------|--|
| <b>HDMI</b>                  |       |      | HDMI connections can carry uncompressed, standard or high definition digital video and digital audio, for the best picture and sound quality.  |
| <b>Component video cable</b> |       |      | Component video separates the luminance (Y) and color difference signals (PR, PB), providing the best picture quality. (Some TV manufacturers label their component video jacks slightly differently.) |
| <b>S-Video cable</b>         |       |      | S-Video separates the luminance and color signals and provides better picture quality than composite video.  |
| <b>Composite video cable</b> |       |      | Composite video is commonly used on TVs, VCRs, and other video equipment.  |

### Audio

|  |  |  |   |
|--|--|--|---|
| <b>Optical digital audio cable</b>           |  |  | This offers the best sound quality and allows you to enjoy Dolby Digital and DTS. The audio quality is the same as for coaxial.   |
| <b>Coaxial digital audio cable</b>           |  |  | This offers the best sound quality and allows you to enjoy Dolby Digital and DTS. The audio quality is the same as for optical.   |
| <b>Analog audio cable (RCA)</b>              |  |  | This cable carries analog audio. It's the most common connection format for analog audio and can be found on virtually all AV components.   |
| <b>Multichannel analog audio cable (RCA)</b> |  |  | This cable carries multichannel analog audio and is typically used to connect DVD players with a 7.1-channel analog audio output. Several standard analog audio cables can be used instead of a multichannel cable. |

**Note:** The AV receiver does not support SCART connections.



## Connecting Audio and Video Signals to the AV Receiver

By connecting both the audio and video outputs of your DVD player and other AV components to the AV receiver, you can switch the audio and video signals simultaneously simply by changing the input source on the AV receiver.

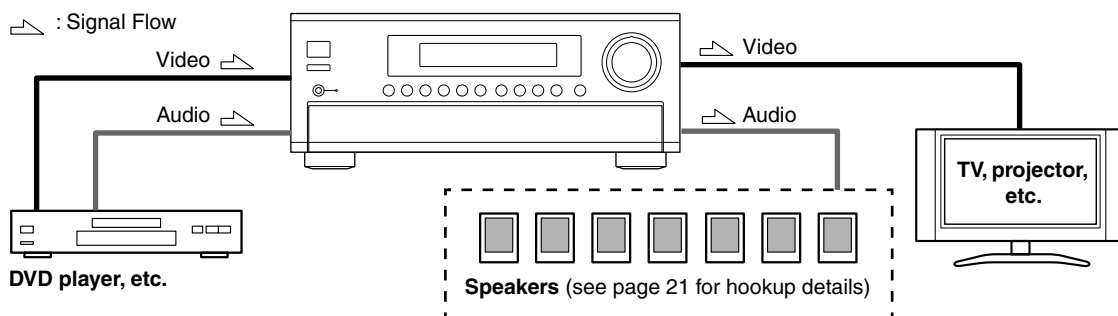

## Which Connections Should I Use?

The AV receiver supports several connection formats for compatibility with a wide range of AV equipment. The format you choose will depend on the formats supported by your other components. Use the following sections as a guide. For video components, you must make an audio connection and a video connection.

### Video Connection Formats

Video equipment can be connected to the AV receiver by using any one of the following video connection formats: composite video, S-Video, component video, or HDMI, the latter offering the best picture quality.

Composite video to S-Video and S-Video to composite video conversion only applies to the MONITOR OUT V and S outputs, not the VIDEO 1 and VIDEO 2 OUT V and S outputs.

**For optimum video performance, THX recommends that video signals pass through the system without upconversion (e.g., component video input through to component video output). It's also recommended that you set the Immediate Display preference to Off (page 78).**

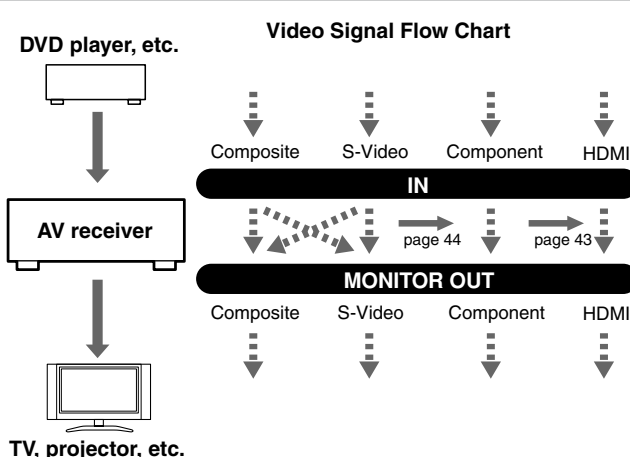

### Audio Connection Formats

Audio equipment can be connected to the AV receiver by using any of the following audio connection formats: analog, optical, coaxial, analog multichannel, or HDMI.

When choosing a connection format, bear in mind that the AV receiver does not convert digital input signals for analog line output and vice versa. For example, audio signals connected to an OPTICAL or COAXIAL input are not output by the analog TAPE OUT.

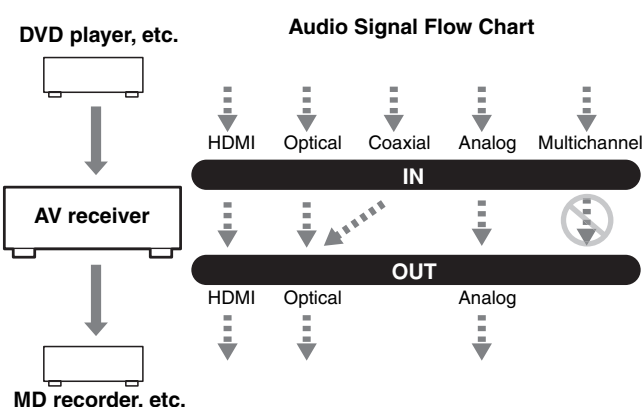

## Connecting Your Components—Continued

### Connecting a TV or Projector

#### Step 1: Video Connection

Choose a video connection that matches your TV (**A**, **B**, or **C**), and then make the connection.

#### Step 2: Audio Connection

Choose an audio connection that matches your TV (**a**, **b**, or **c**), and then make the connection.

- With connection **a**, you can listen to and record audio from your TV and listen in Zone 2.
- To enjoy Dolby Digital and DTS, use connection **b** or **c**. (For recording, use **a** and **b**, or **a** and **c**.)

| Connection | AV receiver          | Signal flow | TV                      | Picture quality |
|------------|----------------------|-------------|-------------------------|-----------------|
| <b>A</b>   | COMPONENT VIDEO OUT  | ⇒           | Component video input   | Best            |
| <b>B</b>   | MONITOR OUT S        | ⇒           | S-Video input           | Better          |
| <b>C</b>   | MONITOR OUT V        | ⇒           | Composite video input   | Standard        |
| <b>a</b>   | VIDEO 3 IN L/R       | ←           | Analog audio L/R output |                 |
| <b>b</b>   | DIGITAL COAXIAL IN 2 | ←           | Digital coaxial output  |                 |
| <b>c</b>   | DIGITAL OPTICAL IN 2 | ←           | Digital optical output  |                 |

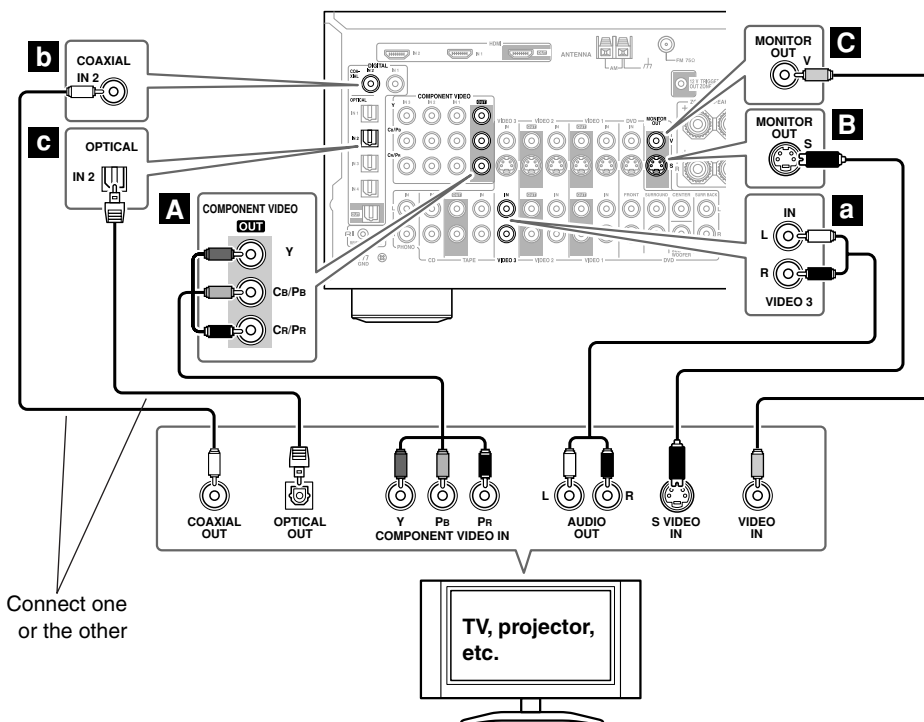

If your TV has no audio outputs, connect an audio output from your VCR or cable or satellite receiver to the AV receiver and use its tuner to listen to TV programs through the AV receiver (see pages 29 and 31).

## Connecting Your Components—Continued

### Connecting a DVD player

#### Step 1: Video Connection

Choose a video connection that matches your DVD player (**A**, **B**, or **C**), and then make the connection. If you use connection **A**, you must connect the AV receiver to your TV with the same type of connection.

#### Step 2: Audio Connection

Choose an audio connection that matches your DVD player (**a**, **b**, or **c**), and then make the connection.

- With connection **a**, you can listen to and record audio from a DVD and listen in Zone 2.
- To enjoy Dolby Digital and DTS, use connection **b** or **c**. (For recording, use **a** and **b**, or **a** and **c**.)
- If your DVD player has main left and right outputs and multichannel left and right outputs, be sure to use the main left and right outputs for connection **a**.

| Connection | AV receiver          | Signal flow | DVD player              | Picture quality |
|------------|----------------------|-------------|-------------------------|-----------------|
| <b>A</b>   | COMPONENT VIDEO IN 1 | ←           | Component video output  | Best            |
| <b>B</b>   | DVD IN S             | ←           | S-Video output          | Better          |
| <b>C</b>   | DVD IN V             | ←           | Composite video output  | Standard        |
| <b>a</b>   | DVD IN FRONT         | ←           | Analog audio L/R output |                 |
| <b>b</b>   | DIGITAL COAXIAL IN 1 | ←           | Digital coaxial output  |                 |
| <b>c</b>   | DIGITAL OPTICAL IN 4 | ←           | Digital optical output  |                 |

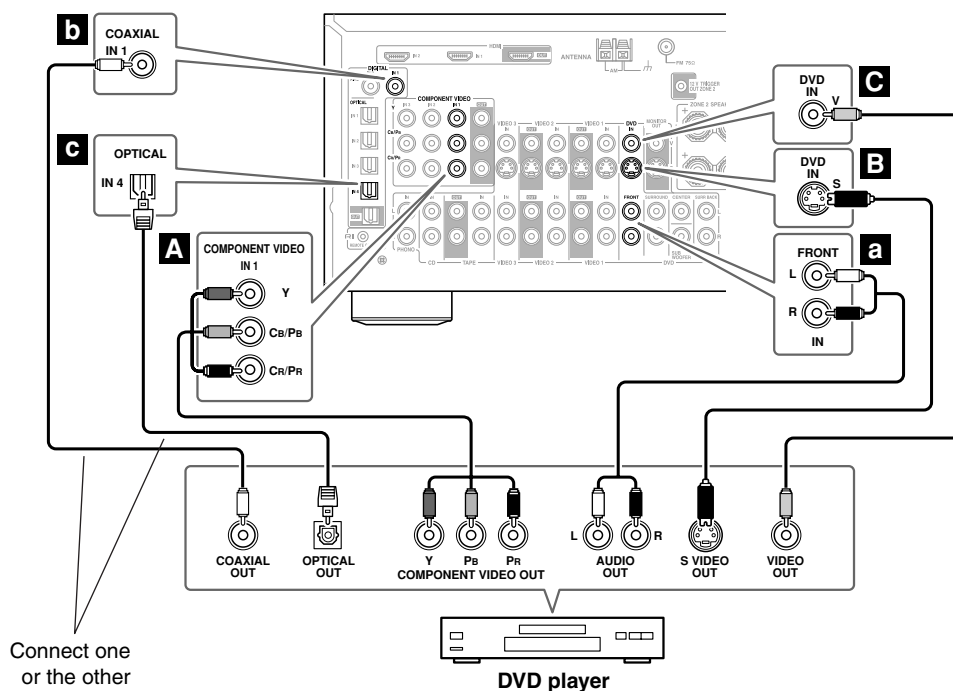

To connect a DVD player or DVD-Audio/SACD-capable player with a multichannel analog audio output, see page 28.

### Hooking Up the Multichannel DVD Input

If your DVD player supports multichannel audio formats such as DVD-Audio or SACD, and it has a multichannel analog audio output, you can connect it to the AV receiver's multichannel DVD input.

Use a multichannel analog audio cable, or several normal audio cables, to connect the AV receiver's DVD IN FRONT L/R, CENTER, SURROUND L/R, SURR BACK L/R, and SUBWOOFER jacks to the 7.1-channel analog audio output on your DVD player. If your DVD player has a 5.1-channel analog audio output, don't connect anything to the AV receiver's SURR BACK L/R jacks. See "Using the Multichannel DVD Input" on page 57 for setup and operation.

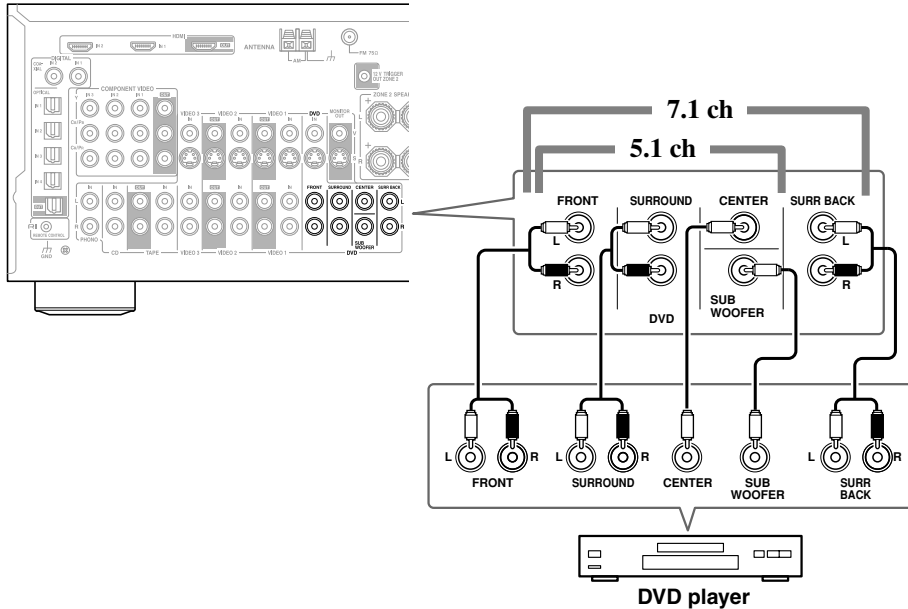

## Connecting Your Components—Continued

### Connecting a VCR or DVD Recorder for Playback



With this hookup, you can use your VCR's tuner to listen to your favorite TV programs via the AV receiver, useful if your TV has no audio outputs.

If you have two video recorders (e.g., a VCR and a DVD recorder), connect one recorder to the VIDEO 1 IN jacks, as shown here, and connect the other recorder to the VIDEO 2 IN jacks in the same way.

#### Step 1: Video Connection

Choose a video connection that matches your VCR or DVD recorder (**A**, **B**, or **C**), and then make the connection. If you use connection **A**, you must connect the AV receiver to your TV with the same type of connection.

#### Step 2: Audio Connection

Choose an audio connection that matches your VCR or DVD recorder (**a**, **b**, or **c**), and then make the connection.

- With connection **a**, you can listen to the VCR or DVD recorder even in Zone 2.
- To enjoy Dolby Digital and DTS, use connection **b** or **c**. (To listen in Zone 2 as well, use **a** and **b**, or **a** and **c**.)

| Connection | AV receiver          | Signal flow | VCR or DVD recorder     | Picture quality |
|------------|----------------------|-------------|-------------------------|-----------------|
| <b>A</b>   | COMPONENT VIDEO IN 2 | ←           | Component video output  | Best            |
| <b>B</b>   | VIDEO 1 IN S         | ←           | S-Video output          | Better          |
| <b>C</b>   | VIDEO 1 IN V         | ←           | Composite video output  | Standard        |
| <b>a</b>   | VIDEO 1 IN L/R       | ←           | Analog audio L/R output |                 |
| <b>b</b>   | DIGITAL COAXIAL IN 2 | ←           | Digital coaxial output  |                 |
| <b>c</b>   | DIGITAL OPTICAL IN 1 | ←           | Digital optical output  |                 |

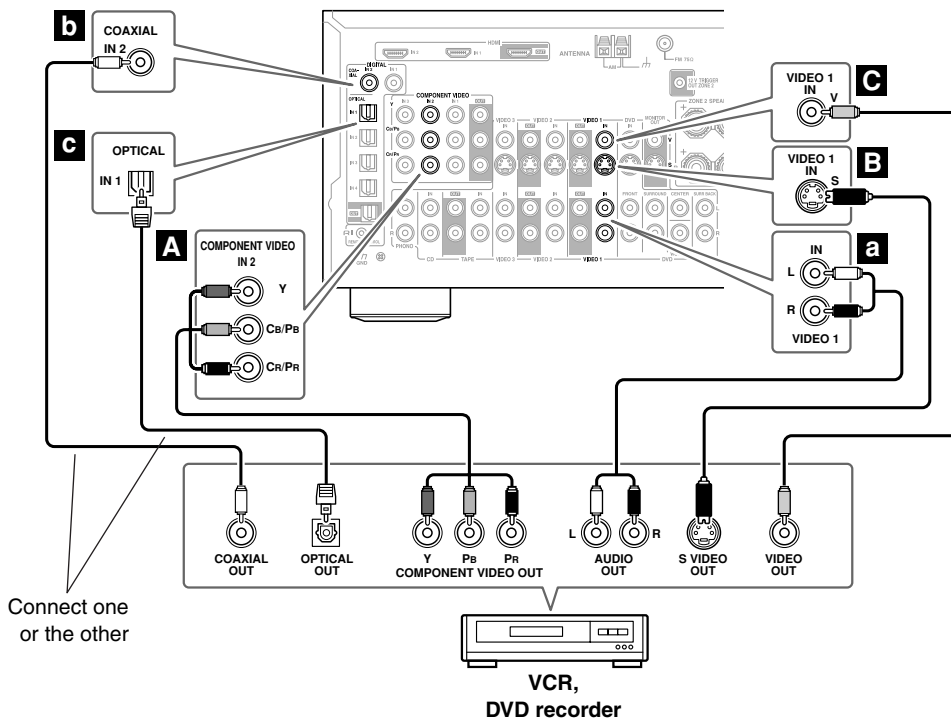

## Connecting Your Components—Continued

### Connecting a VCR or DVD Recorder for Recording

If you have two video recorders (e.g., a VCR and a DVD recorder), connect one recorder to the VIDEO 1 OUT jacks, as shown here, and connect the other recorder to the VIDEO 2 OUT jacks in the same way.

#### Step 1: Video Connection

Choose a video connection that matches your VCR or DVD recorder (**A** or **B**), and then make the connection. The video source to be recorded must be connected to the AV receiver via the same type of connection.

#### Step 2: Audio Connection

Choose an audio connection that matches your VCR or DVD recorder (**a** or **b**), and then make the connection.

| Connection | AV receiver         | Signal flow | VCR or DVD recorder   | Picture quality |
|------------|---------------------|-------------|-----------------------|-----------------|
| <b>A</b>   | VIDEO 1 OUT S       | ⇒           | S-Video input         | Better          |
| <b>B</b>   | VIDEO 1 OUT V       | ⇒           | Composite video input | Standard        |
| <b>a</b>   | VIDEO 1 OUT L/R     | ⇒           | Audio L/R input       |                 |
| <b>b</b>   | DIGITAL OPTICAL OUT | ⇒           | Digital optical input |                 |

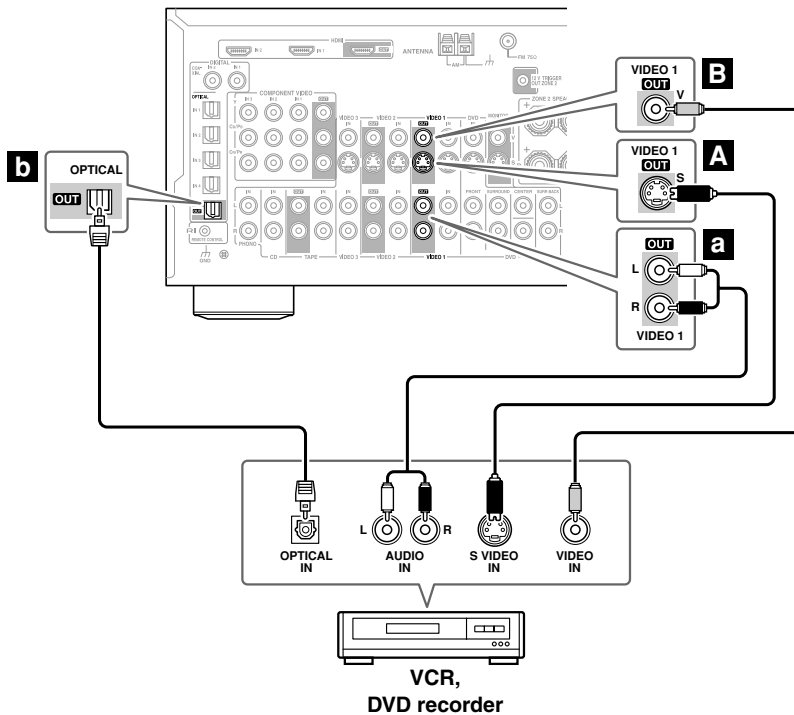

#### Notes:

- The AV receiver must be turned on for recording. Recording is not possible while it's in Standby mode.
- If you want to record directly from your TV or playback VCR to the recording VCR without going through the AV receiver, connect the TV/VCR's audio and video outputs directly to the recording VCR's audio and video inputs. See the manuals supplied with your TV and VCR for details.
- Video signals connected to composite video inputs can only be recorded via composite video outputs. If your TV/VCR is connected to a composite video input, the recording VCR must be connected to a composite video output. Similarly, video signals connected to S-Video inputs can only be recorded via S-Video outputs. If your TV/VCR is connected to an S-Video input, the recording VCR must be connected to an S-Video output.

## Connecting Your Components—Continued

### Connecting a Satellite, Cable, Set-top box, or Other Video Source



With this hookup, you can use your satellite or cable receiver to listen to your favorite TV programs via the AV receiver, useful if your TV has no audio outputs.

#### Step 1: Video Connection

Choose a video connection that matches the video source (**A**, **B**, or **C**), and then make the connection. If you use connection **A**, you must connect the AV receiver to your TV with the same type of connection.

#### Step 2: Audio Connection

Choose an audio connection that matches the video source (**a**, **b**, or **c**), and then make the connection.

- With connection **a**, you can listen to and record audio from the video source and listen in Zone 2.
- To enjoy Dolby Digital and DTS, use connection **b** or **c**. (For recording, use **a** and **b**, or **a** and **c**.)

| Connection | AV receiver          | Signal flow | Video source            | Picture quality |
|------------|----------------------|-------------|-------------------------|-----------------|
| <b>A</b>   | COMPONENT VIDEO 3 IN | ←           | Component video output  | Best            |
| <b>B</b>   | VIDEO 3 IN S         | ←           | S-Video output          | Better          |
| <b>C</b>   | VIDEO 3 IN V         | ←           | Composite video output  | Standard        |
| <b>a</b>   | VIDEO 3 IN L/R       | ←           | Analog audio L/R output |                 |
| <b>b</b>   | DIGITAL COAXIAL IN 2 | ←           | Digital coaxial output  |                 |
| <b>c</b>   | DIGITAL OPTICAL IN 2 | ←           | Digital optical output  |                 |

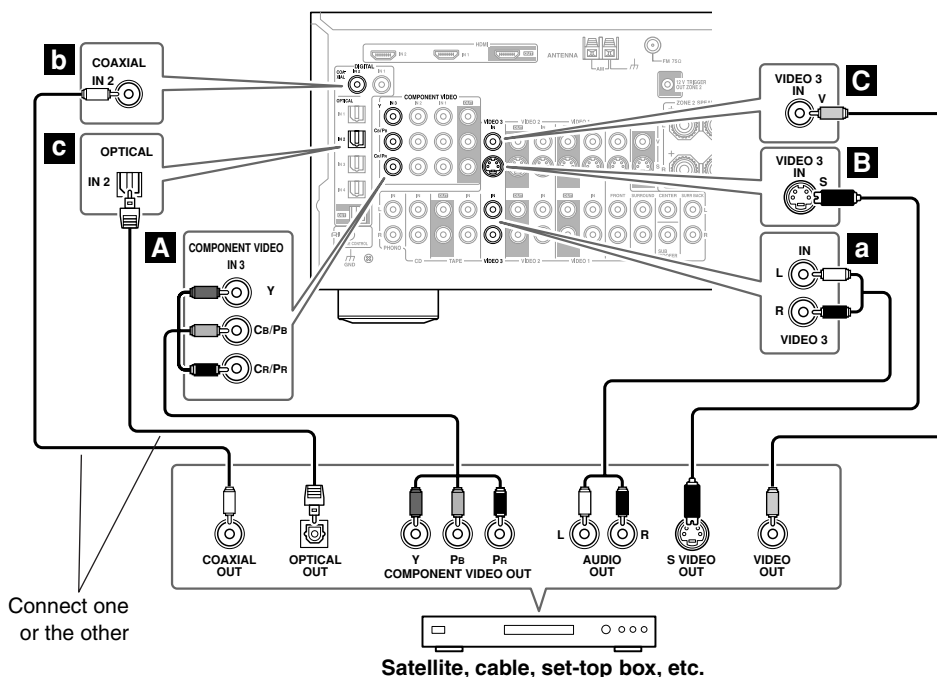

### Connecting Components with HDMI

#### About HDMI

Designed to meet the demands of digital TV, HDMI (High Definition Multimedia Interface) is a new digital interface standard for connecting TVs, projectors, DVD players, set-top boxes, and other video components. Until now, several separate video and audio cables have been required to connect AV components. With HDMI, a single cable can carry control signals, digital video, and up to eight channels of digital audio (2-channel PCM, multichannel digital audio, and multichannel PCM).

The HDMI video stream (i.e., video signal) is compatible with DVI (Digital Visual Interface),<sup>\*1</sup> so TVs and displays with a DVI input can be connected by using an HDMI-to-DVI adapter cable. (This may not work with some TVs and displays, resulting in no picture.)

The AV receiver uses HDCP (High-bandwidth Digital Content Protection), so only HDCP-compatible components can display the picture.

The AV receiver's HDMI interface is based on the following standard:  
High-Definition Multimedia Interface Specification Informational Version 1.1

#### Supported Audio Formats

- 2-channel linear PCM (32–192 kHz, 16/20/24 bit)
- Multichannel linear PCM (5.1 ch, 32–96 kHz, 16/20/24 bit)
- Bitstream (Dolby Digital, DTS)

Your DVD player must be able to output these formats from its HDMI OUT.

#### About Copyright Protection

The AV receiver supports HDCP (High-bandwidth Digital Content Protection),<sup>\*2</sup> a copy-protection system for digital video signals. Other devices connected to the AV receiver via HDMI must also support HDCP.

Commercially available HDMI cables (supplied with some components) should be used to connect the AV receiver's HDMI OUT to the HDMI input on your TV or projector.

\*1 DVI (Digital Visual Interface): The digital display interface standard set by the DDWG<sup>\*3</sup> in 1999.

\*2 HDCP (High-bandwidth Digital Content Protection): The video encryption technology developed by Intel for HDMI/DVI. It's designed to protect video content and requires a HDCP-compatible device to display the encrypted video.

\*3 DDWG (Digital Display Working Group): Led by Intel, Compaq, Fujitsu, Hewlett Packard, IBM, NEC, and Silicon Image, this open industry group's objective is to address the industry's requirements for a digital connectivity specification for high-performance PCs and digital displays.



## Connecting Your Components—Continued

### Making HDMI Connections

**Step 1:** Use HDMI cables to connect the AV receiver's HDMI jacks to your HDMI-compatible DVD player, TV, projector, and so on.

**Step 2:** Assign each HDMI IN to an input selector in the HDMI Video setup (see page 43).

#### Video Signal Flow Chart

Digital video signals received at HDMI IN 1 and 2 are only output by the HDMI OUT and sent to your TV. By changing a setting on the AV receiver, input signals from the composite video, S-Video, and component video inputs can be output by the HDMI OUT (see pages 43, 44).

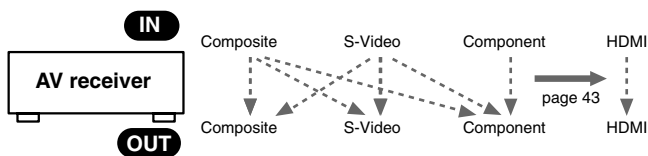

#### Audio Signal Flow Chart

Digital audio signals received at HDMI IN 1 or 2 are output by the speakers and headphones connected to the AV receiver. They can be output by the HDMI OUT by setting the HDMI Audio Out setting to On (see page 78).

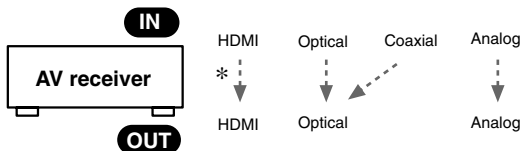

\* To listen to audio received at HDMI IN 1 and 2 through your TV's speakers, set the HDMI Audio Out setting to On (see page 78), and set your DVD player's HDMI audio output setting to PCM.

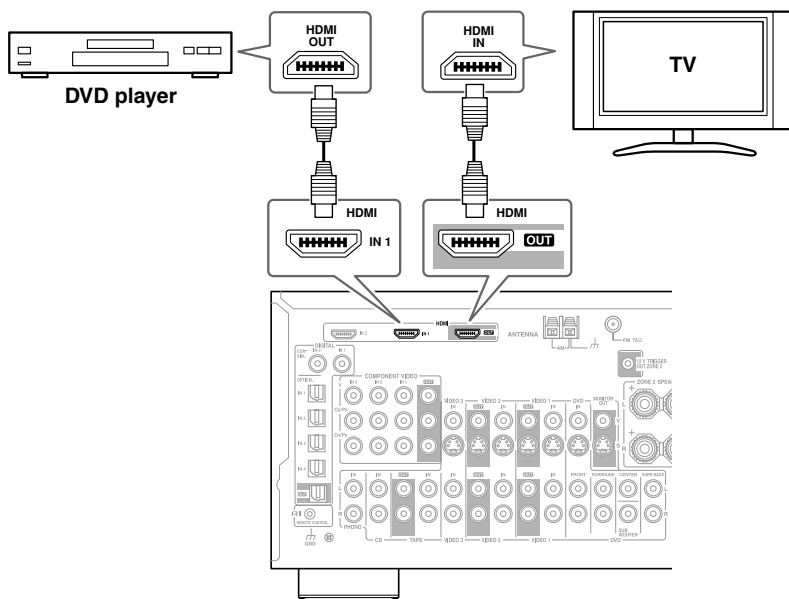

## Connecting Your Components—Continued

### Connecting a Camcorder, Games Console, or Other Device

#### Step 1: Video Connection

Choose a video connection that matches the camcorder or console (**A** or **B**), and then make the connection.

#### Step 2: Audio Connection

Choose an audio connection that matches the camcorder or console (**a** or **b**), and then make the connection.

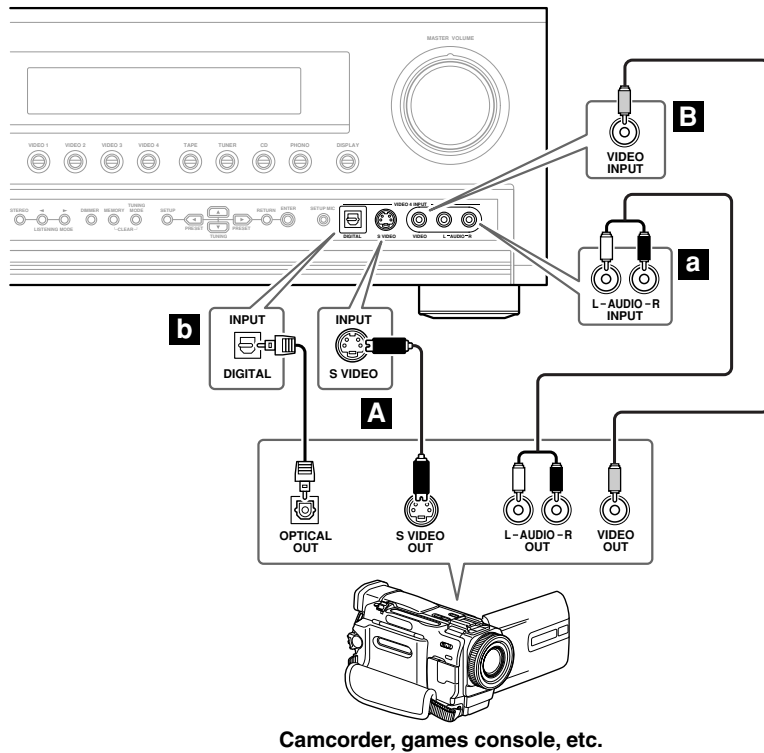

| Connection | AV receiver           | Signal flow | Camcorder or console    |
|------------|-----------------------|-------------|-------------------------|
| <b>A</b>   | VIDEO 4 INPUT S VIDEO | ←           | S-Video output          |
| <b>B</b>   | VIDEO 4 INPUT VIDEO   | ←           | Composite video output  |
| <b>a</b>   | VIDEO 4 INPUT L/R     | ←           | Analog audio L/R output |
| <b>b</b>   | VIDEO 4 INPUT DIGITAL | ←           | Digital optical output  |

## Connecting Your Components—Continued

### Connecting a CD Player

#### Step 1:

Choose a connection that matches your CD player (**a**, **b**, or **c**), and then make the connection.

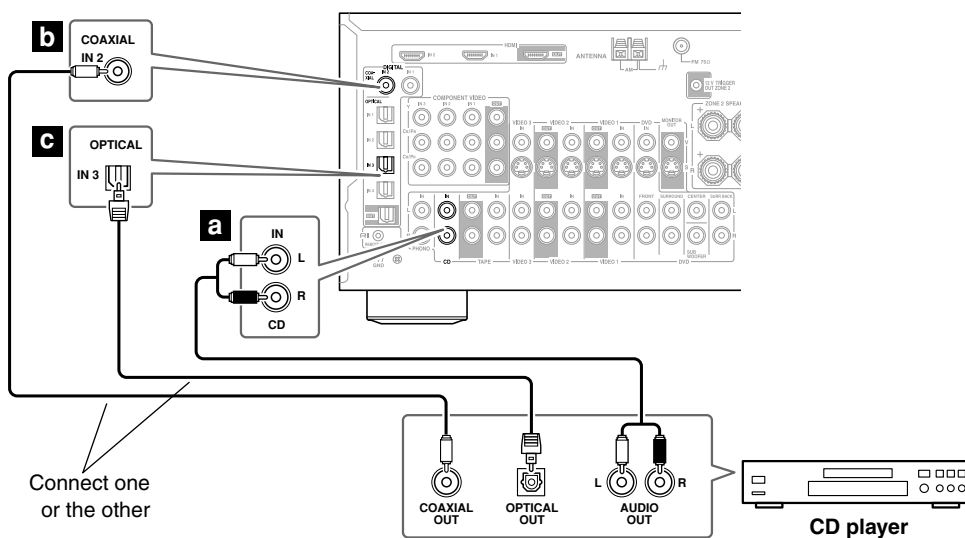

- With connection **a**, you can listen to and record audio from the CD player and listen in Zone 2.
- To connect the CD player digitally, use connection **b** or **c**. (For recording, use **a** and **b**, or **a** and **c**.)

| Connection | AV receiver          | Signal flow | CD                      |
|------------|----------------------|-------------|-------------------------|
| <b>a</b>   | CD IN L/R            | ←           | Analog audio L/R output |
| <b>b</b>   | DIGITAL COAXIAL IN 2 | ←           | Digital coaxial output  |
| <b>c</b>   | DIGITAL OPTICAL IN 3 | ←           | Digital optical output  |

### Connecting a Turntable

The AV receiver's PHONO IN is for use with a moving magnet (MM) type cartridge.

Use an analog audio cable to connect the AV receiver's PHONO IN L/R jacks to the audio output on your turntable.

#### Notes:

- If your turntable has a ground wire, connect it to the AV receiver's GND screw. With some turntables, connecting the ground wire may produce an audible hum. If this happens, disconnect it.
- If your turntable has a moving coil (MC) type cartridge, you'll need a commercially available MC head amp or MC transformer. Connect your turntable to the head amp or transformer, and connect that to the AV receiver's PHONO IN L/R jacks.
- You can also use a phono equalizer to connect a turntable with an MC-type cartridge. See the phono equalizer's manual for details.

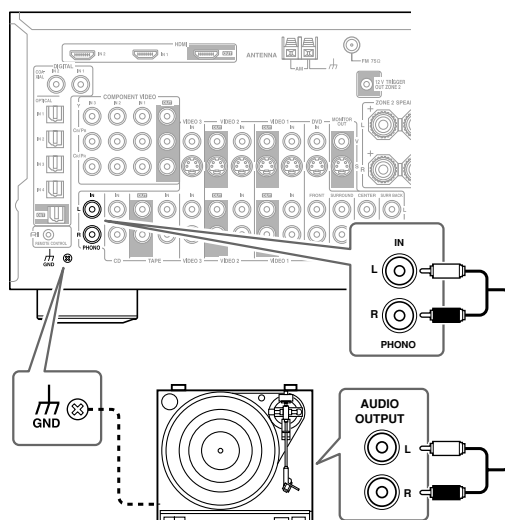

## Connecting a Cassette, CDR, MiniDisc, or DAT Recorder

### Step 1:

Choose a connection that matches the recorder (**a**, **b**, **c**, or **d**), and then make the connection.

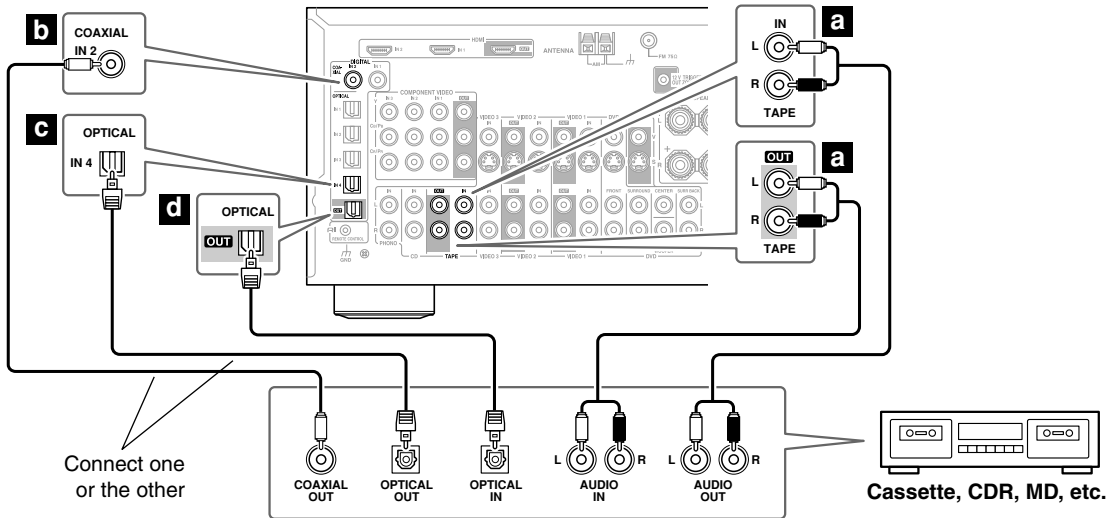

- With connection **a**, you can play and record and listen in Zone 2.
- To connect the recorder digitally for playback, use connections **a** and **b**, or **a** and **c**.
- To connect the recorder digitally for recording, use connection **d**.

| Connection | AV receiver                 | Signal flow | Cassette, CDR, MD, or DAT recorder                |
|------------|-----------------------------|-------------|---|
| <b>a</b>   | TAPE IN L/R<br>TAPE OUT L/R | ←<br>⇒      | Analog audio L/R output<br>Analog audio L/R input |
| <b>b</b>   | DIGITAL COAXIAL IN 2        | ←           | Digital coaxial output                            |
| <b>c</b>   | DIGITAL IN OPTICAL IN 4     | ←           | Digital optical output                            |
| <b>d</b>   | DIGITAL OPTICAL OUT         | ⇒           | Digital optical input                             |

## Connecting a Power Amplifier

If you want to use a more powerful power amplifier and use the AV receiver as a preamp, connect it to the PRE OUT jacks, and connect all speakers and the subwoofer to the power amplifier. If you have a powered subwoofer, connect it to this AV receiver's PRE OUT SUBWOOFER jack.

1. Subwoofer
2. Front left speaker
3. Center speaker
4. Front right speaker
5. Surround left speaker
6. Surround right speaker
7. Surround back left speaker
8. Surround back right speaker

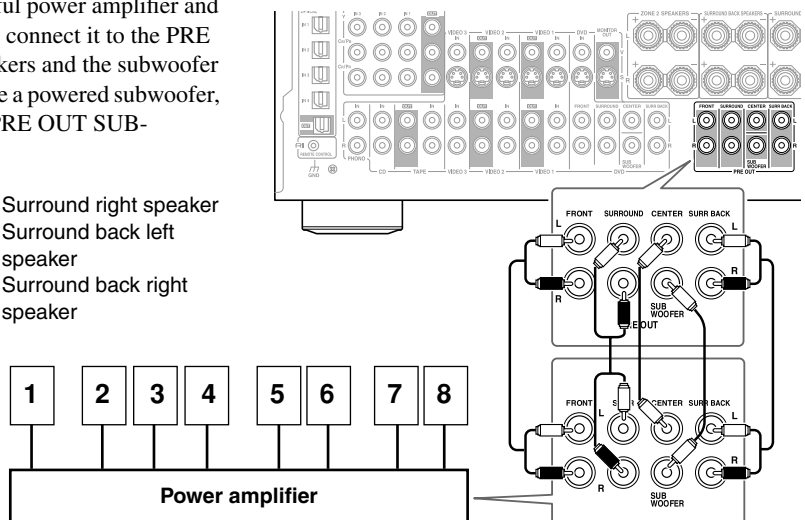

## Connecting Your Components—Continued

### Connecting an HDD-compatible Component

As of this printing, the Onkyo Remote Interactive Dock is the only HDD-compatible component available.

#### ■ For HDD-compatible components that support video

Connect your HDD-compatible component's analog audio output jacks and video output jack to the AV receiver's VIDEO 3 IN L/R jacks and VIDEO 3 IN (V or S) jack.

(The hookup example below shows how to connect the DS-A1.)

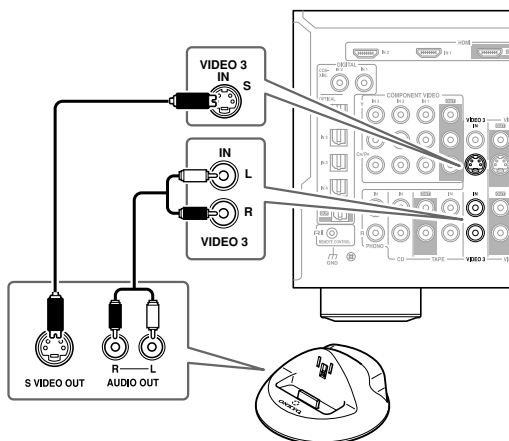

#### ■ For HDD-compatible components that don't support video

Connect your HDD-compatible component's analog audio output jacks to the AV receiver's TAPE IN L/R jacks.

(The hookup example below shows how to connect the DS-A1.)

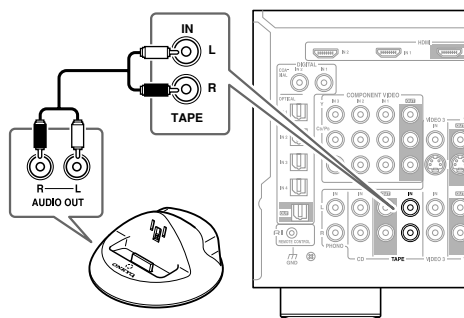

#### Notes:

- Connect the Remote Interactive Dock with an **RI** cable (see page 38).
- Set the Remote Interactive Dock's RI MODE switch to HDD.
- Set the AV receiver's Input Display to HDD (see page 46).
- Refer to the Remote Interactive Dock's instruction manual.

### Connecting the Power Cords of Other Components

The AV receiver has AC outlets on its rear panel that can be used to connect the power cords of other components that you intend to use with the AV receiver. These components can then be left turned on so that they turn on and off as and when the AV receiver is turned on and set to Standby.

#### Caution:

- Make sure that the total capacity of the components that you connect to the AC OUTLETS does not exceed the stated capacity (e.g., TOTAL 120 W).

#### Note:

- Onkyo components connected via **RI** should be connected directly to a wall outlet, not an AC OUTLET on the AV receiver.
- The number of AC OUTLETS, socket type, and total capacity depends on the country in which you purchased the AV receiver.

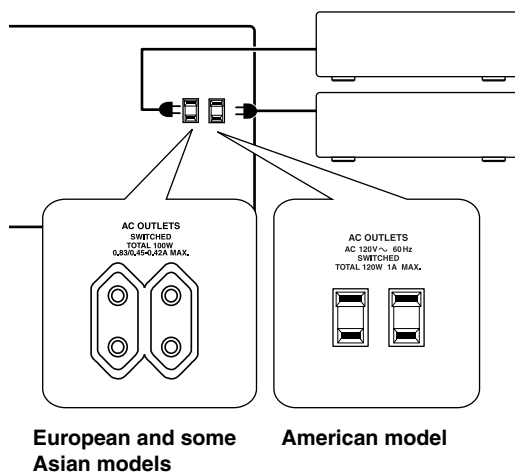

### Connecting Onkyo **RI** Components

**Step 1:** Make sure that each Onkyo component is connected to the AV receiver with an analog audio cable (RCA).

**Step 2:** Make the **RI** connection.

**Step 3:** If you're using an MD, CDR, or HDD component, change the Input Display (see page 46).

With **RI** (Remote Interactive), you can use the following special functions:

#### Auto Power On/Standby

When you start playback on a component connected via **RI**, if the AV receiver is on Standby, it will automatically turn on and select that component as the input source. Similarly, when the AV receiver is set to Standby, all components connected via **RI** will also go on Standby. This function will not work with components connected to an AC OUTLET on the AV receiver.

#### Direct Change

When playback is started on a component connected via **RI**, the AV receiver automatically selects that component as the input source. If your DVD player is connected to the AV receiver's multichannel DVD input, you'll need to press the [MULTI CH] button to hear all channels (page 57), as the Direct Change **RI** function only selects the FRONT jacks.

#### Remote Control

You can use the AV receiver's remote controller to control your other **RI**-capable Onkyo components, pointing the remote controller at the AV receiver's remote control sensor instead of the component. You must enter the appropriate remote control code first (see page 87).

#### Notes:

- Use only **RI** cables for **RI** connections. **RI** cables are supplied with Onkyo players (DVD, CD, etc.).
- Some components have two **RI** jacks. You can connect either one to the AV receiver. The other jack is for connecting additional **RI**-capable components.
- Connect only Onkyo components to **RI** jacks. Connecting other manufacturer's components may cause a malfunction.
- Some components may not support all **RI** functions. Refer to the manuals supplied with your other Onkyo components.

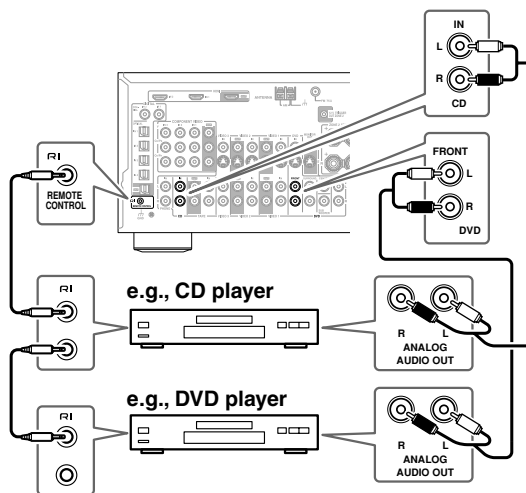

### Connecting the Power Cord

- Before connecting the power cord, connect all your speakers and AV components.
- Connect the AV receiver's power cord to a suitable wall outlet.
- Turning on the AV receiver may cause a momentary power surge that might interfere with other electrical equipment on the same circuit. If this is a problem, plug the AV receiver into a different branch circuit.

# Turning On the AV Receiver

- North American and Australian models

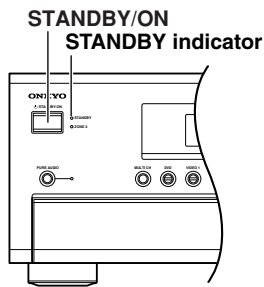

- Other models

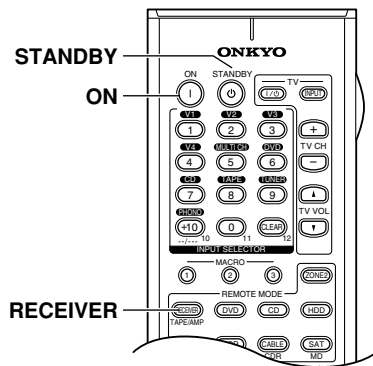
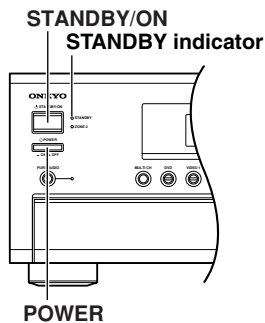

## Turning On and Standby

1



Set the [POWER] switch to the ON position (☐).  
 (Skip this step if you have the North American or Australian model.)  
 The AV receiver enters Standby mode, and the STANDBY indicator comes on.

2

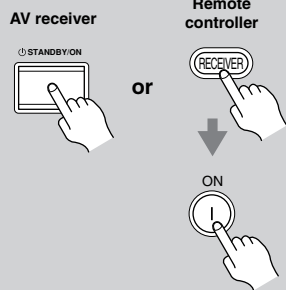

Press the [STANDBY/ON] button.  
 Alternatively, press the remote controller's [RECEIVER] button, followed by the [ON] button.

The AV receiver comes on, the display lights up, and the STANDBY indicator goes off. Pressing the remote controller's [ON] button again will turn on any components connected via **RI**.

To turn the AV receiver off, press the [STANDBY/ON] button, or press the remote controller's [STANDBY] button. The AV receiver will enter Standby mode. To prevent any loud surprises when you turn on the AV receiver, always turn down the volume before you turn it off.

### For models other than the North American and Australian models:

- To completely shut down the AV receiver, set the [POWER] switch to the OFF position (■).

## Smooth Operation in a Few Easy Steps

To ensure smooth operation, here's a few easy steps to help you configure the AV receiver before you use it for the very first time. These settings only need to be made once.

### ■ Do the automatic speaker setup—this is essential!

See "Automatic Speaker Setup" on page 40.



### ■ Have you connected a component to an HDMI input, component video input, or digital audio input?

If you have, see "HDMI Video Setup" on page 43, "Component Video Setup" on page 44, or "Digital Audio Input Setup" on page 45 respectively.

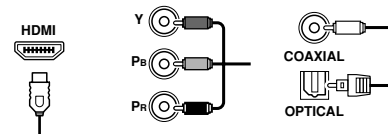

### ■ Have you connected an Onkyo MD recorder, CD recorder, or next generation HDD-compatible component?

If you have, see "Changing the Input Display" on page 46.

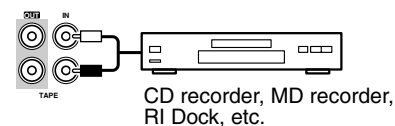

# First Time Setup

This section explains the settings that you need to make before using the AV receiver for the very first time.

## Automatic Speaker Setup

With the supplied speaker setup microphone, the Automatic Speaker Setup function can measure the test tone output by each speaker and automatically determine the number of speakers connected, the crossover frequency, the distance from each speaker to the listening position, and so on. Before using this function, connect and position all of your speakers.

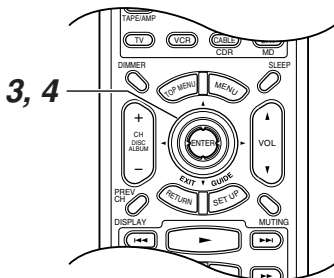
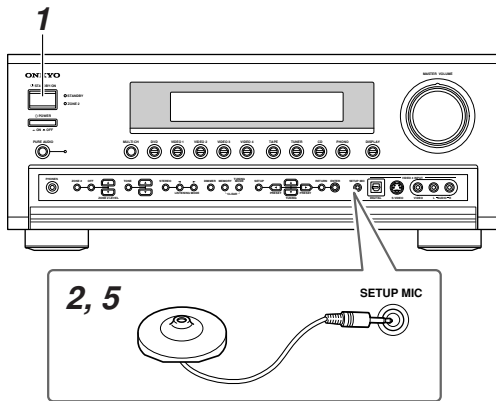

Note: If any of your speakers is 4 ohms, change the minimum speaker impedance setting before running the automatic speaker setup (see page 46).

**1**

**Turn on the AV receiver and the connected TV.**

On the TV, select the input to which the AV receiver is connected.

**2**

**Put the speaker setup microphone in the listening position.**

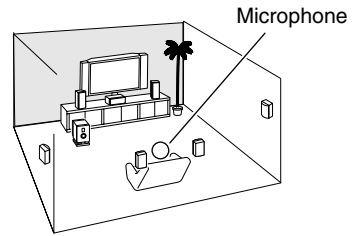

**Notes:**

- Make sure the microphone is horizontal.
- If there's an obstacle between the microphone and any speaker, the automatic setup will not work correctly. Set up the room as you would when enjoying a DVD.
- Positioning the microphone close to where your ears would normally will provide better results. You can adjust the height of the microphone by using a tripod or level table.

**Connect the setup microphone to the SETUP MIC jack.**

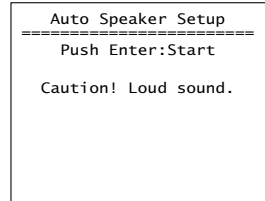

**Notes:**

- If the AV receiver was previously muted, it will be unmuted.
- Automatic speaker setup cannot be performed while a pair of headphones is connected.



### 3



#### Press [ENTER].

The automatic speaker setup starts. The test tone is output by each speaker in turn. The microphone picks up the sound and feeds it back to the AV receiver, where it's used to calculate the optimum speaker settings. The whole process takes about 2 minutes.

```

Auto Speaker Setup
=====
Do not unplug Setup Mic.

Please, keep quiet.

Now measuring

Left
    
```

#### Note:

- If any extraneous noise is picked up by the microphone, the automatic setup may not work correctly, so keep quiet.

### 4

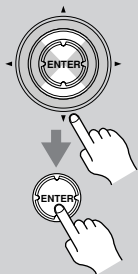

#### On completion, the following menu appears.

```

Auto Speaker Setup
=====
->Apply the Results
Check the Results
Retry
Retry with
Test noise Level up
Cancel
    
```

Use the Up and Down [▲]/[▼] buttons to select one of the following options, and then press [ENTER].

#### Apply the Results:

Select this to save the results, then continue with step 5. Normally, you'd select this option.

#### Check the Results:

Select this if you want to view the results. See "Checking the Results" on page 42.

#### Retry:

Select this if you want to run the automatic speaker setup again, starting from step 3.

#### Retry with Test noise Level up:

Select this to run the automatic speaker setup again but with the test tone louder, starting from step 3.

#### Cancel:

Select this to cancel the automatic speaker setup without saving the results, then continue with step 5.

### 5

#### Disconnect the speaker setup microphone.

```

Auto Speaker Setup
=====

Please, unplug Setup Mic.
    
```

#### Tip:

- You can cancel the automatic speaker setup at anytime by disconnecting the microphone.

## ■ Checking the Results

If you selected “Check the Results” in step 4 on the previous page, the following menu appears and you can check the results of the automatic speaker setup.

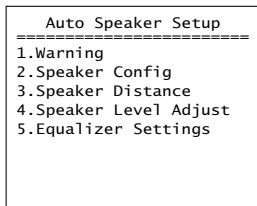

- 1. Warning**—Undetected speakers and position warnings (see the right column).
- 2. Speaker Config**—Connected speakers and crossover frequencies.
- 3. Speaker Distance**—Distance from each speaker to the listening position.
- 4. Speaker Level Adjust**—Optimum volume level for each speaker.
- 5. Equalizer Settings**—Optimum equalizer settings for each speaker.

**Use the Up and Down [▲]/[▼] buttons to select the item that you want to check, and then press [ENTER].**  
Press the [RETURN] button to return to the previous menu.

```

1.Warning
-----
Not Detect:

Distance Error:

2.Speaker Config
-----
Subwoofer      :No
Front         :80Hz(THX)
Center        :80Hz(THX)
Surround      :80Hz(THX)
SurrBack      :80Hz(THX)
SurrBack ch   :2ch

3.Speaker Distance
-----
Left          :12ft
Center        :12ft
Right         :12ft
Surround R    : 7ft
SurrBack      : 7ft
Surround L    : 7ft
Subwoofer     :12ft

4.Speaker Level Adjust
-----
Left          : 0dB
Center        : 0dB
Right         : 0dB
Surround R    : 0dB
SurrBack      : 0dB
Surround L    : 0dB
Subwoofer     : 0dB

5.Equalizer Setting
-----
Channel: Left
-----
80Hz          : 0dB
250Hz         : 0dB
800Hz         : 0dB
2.5kHz        : 0dB
8kHz          : 0dB
    
```

**When you've finished checking, press the [RETURN] button to return to the menu in step 4.**

```

Auto Speaker Setup
-----
->Apply the Results
Check the Results
Retry
Retry with
Test noise Level up
Cancel
    
```

## Warning Messages

In the warning messages, abbreviations are used to identify the speakers (e.g., “L” for left, “R” for right, and so on).

### Not Detect:

The speaker was not detected. Make sure that it's connected properly.

### Distance Error:

The speaker is either too close or too far away, or the distance could not be measured. Reposition the speaker.

## Changing the Speaker Settings Manually:

In some situations, the measurements taken by the automatic speaker setup may not provide usable results. If running the speaker setup a second time still doesn't provide usable results, you'll have to set the speaker settings yourself (see pages 70–75).

Please note that any THX main speakers should be set to 80 Hz (THX). If you set up your speakers using Automatic Speaker Setup, please make sure manually that any THX speakers are set to 80 Hz (THX) in the Speaker Configuration setting (see pages 70, 71).

Sometimes due to the electrical complexities of subwoofers and the interaction with the room, THX recommends setting the level and the distance of the subwoofer manually.

## Using a Powered Subwoofer:

If you're using a powered subwoofer, because it's positioned low down on the floor and outputting very low frequency sounds, its output may not be detected properly. If the subwoofer (abbreviation “SW”) appears on the Warning screen under Not Detect, turn up the subwoofer's volume and run the automatic speaker setup again. If the subwoofer has a built-in crossover, set it to the highest crossover frequency. If it has an LPF filter switch, set it to off or direct. Refer to your subwoofer's instruction manual for details.

**HDMI Video Setup**

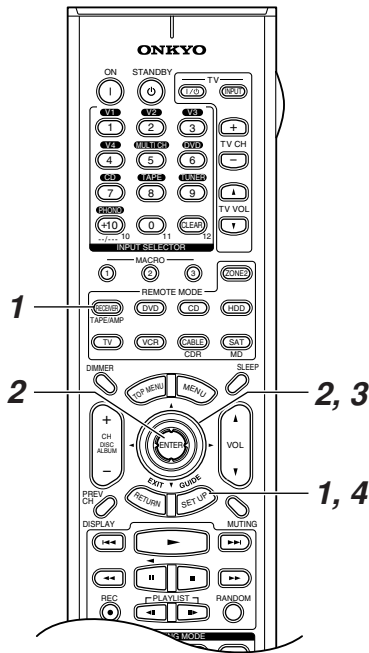

If you connect a video component to HDMI IN 1 or 2, you must assign that input to an input selector. For example, if you connect your DVD player to HDMI IN 1, you must assign HDMI IN 1 to the DVD input selector. Even if a video component has no HDMI output, the AV receiver can upconvert (\*) composite video, S-Video, and component video and output it from the HDMI output. To do this, select the “- - -” option.

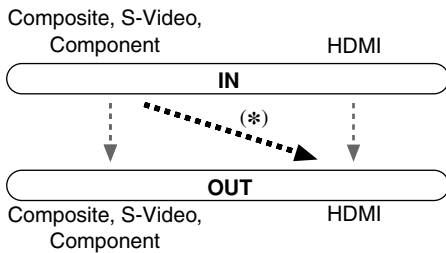

**Note:**

When HDMI IN 1 or 2 is assigned to an input selector here, the digital audio input for that selector is automatically set to HDMI IN 1 or 2. See “Digital Audio Input Setup” on page 45.

**1** Press the [RECEIVER] button, followed by the [SETUP] button. The main menu appears onscreen.

**2** Use the Up and Down [▲]/[▼] buttons to select “0.HDMI Video,” and then press [ENTER]. The HDMI Video menu appears.

0.HDMI Video

---

a. DVD :--: [00]

b. VIDE01 :--: [00]

c. VIDE02 :--: [00]

d. VIDE03 :--: [00]

e. VIDE04 :--: [00]

**3** Use the Up and Down [▲]/[▼] buttons to select an input selector, and use the Left and Right [◀]/[▶] buttons to select:

- IN1:** Select if the video component is connected to HDMI IN 1.
- IN2:** Select if the video component is connected to HDMI IN 2.
- - -:** Select this to output composite video, S-Video, and component video sources from the HDMI OUT. The video signal output by the HDMI OUT is the one selected in the “Component Video Setup” on page 44.

**4** Press the [SETUP] button. Setup closes.

**Component Video Setup**

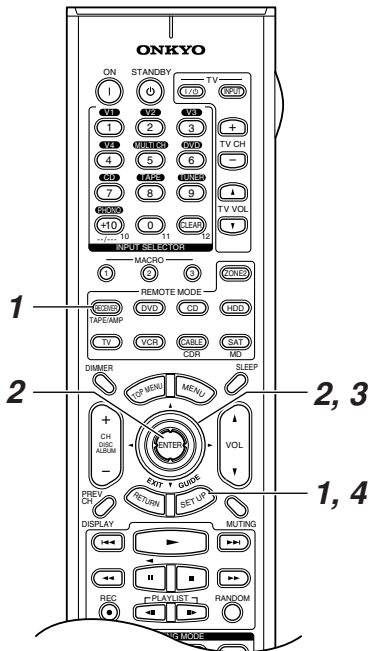

If you connect a video component to COMPONENT VIDEO IN 1, 2, or 3, you must assign that input to an input selector. For example, if you connect your DVD player to COMPONENT VIDEO IN 3, you must assign COMPONENT VIDEO IN 3 to the DVD input selector. To upconvert (\*) composite video and S-Video sources and output them from the component video output, select the “- - -” option.

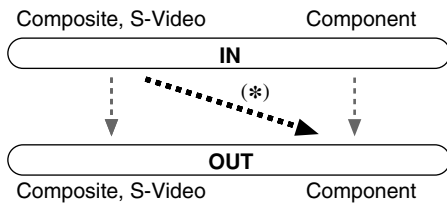

Here are the default assignments.

| Input selector | Default assignment |
|----------------|--------------------|
| DVD            | IN1                |
| VIDEO 1        | - - -              |
| VIDEO 2        | - - -              |
| VIDEO 3        | - - -              |
| VIDEO 4        | - - -              |

**1** Press the [RECEIVER] button, followed by the [SETUP] button. The main menu appears onscreen.

**2** Use the Up and Down [▲]/[▼] buttons to select “1. Component Video,” and then press [ENTER]. The Component Video menu appears.

1.Component Video

---

a.DVD : IN1

b.VIDEO1 : - - -

c.VIDEO2 : - - -

d.VIDEO3 : - - -

e.VIDEO4 : - - -

**3** Use the Up and Down [▲]/[▼] buttons to select an input selector, and use the Left and Right [◀]/[▶] buttons to select:

**IN1:** Select if the video component is connected to COMPONENT VIDEO IN 1.

**IN2:** Select if the video component is connected to COMPONENT VIDEO IN 2.

**IN3:** Select if the video component is connected to COMPONENT VIDEO IN 3.

**- - -:** Select to output composite video and S-Video sources from the COMPONENT VIDEO OUT.

**4** Press the [SETUP] button. Setup closes.

**Notes:**

- This procedure can also be performed on the AV receiver by using its [SETUP] button, arrow buttons, and [ENTER] button.
- When the input selector assignment for the COMPONENT VIDEO IN jacks is set to IN1, IN2 or IN3, the “composite video to S-Video” and “S-Video to composite video” conversions will not work.

Digital Audio Input Setup

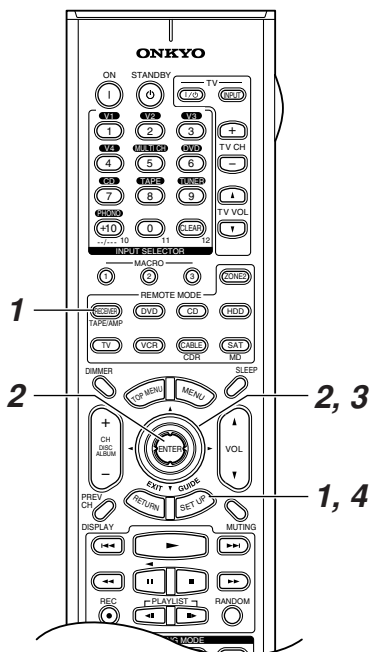

If you connect a component to a digital input, you must assign that input to an input selector. For example, if you connect your CD player to OPTICAL IN 2, you must assign OPTICAL IN 2 to the CD input selector.

Here are the default assignments.

| Input selector | Default assignment |
|----------------|--------------------|
| DVD            | Coax 1             |
| VIDEO 1        | Opt 1              |
| VIDEO 2        | -----              |
| VIDEO 3        | Opt 2              |
| VIDEO 4        | Front *            |
| TAPE           | -----              |
| CD             | Opt 3              |
| PHONO          | -----              |

\* The front panel optical DIGITAL input.

- When HDMI IN 1 or 2 is assigned to an input selector in the “HDMI Video Setup” on page 43, the input selector assignment on this page is automatically set to HDMI 1 or HDMI 2.

**1** Press the [RECEIVER] button, followed by the [SETUP] button. The main menu appears onscreen.

**2** Use the Up and Down [▲]/[▼] buttons to select “2. Digital Input,” and then press [ENTER]. The Digital Input menu appears.

2. Digital Input

a. DVD : Coax1 00

b. VIDEO1 : Opt1 00

c. VIDEO2 : ----- 00

d. VIDEO3 : Opt2 00

e. VIDEO4 : Front 00

f. TAPE : ----- 00

g. CD : Opt3 00

h. PHONO : ----- 00

**3** Use the Up and Down [▲]/[▼] buttons to select an input selector, and then use the Left and Right [◀]/[▶] buttons to select: Coax 1, Coax 2, Opt 1, Opt 2, Opt 3, Opt 4, or ----- (analog).

For input selectors that you want to use with an analog input, select “-----.”

- Inputs cannot be assigned to the TUNER input selector.
- The front panel optical DIGITAL input (i.e., Front) can only be assigned to the VIDEO 4 input selector.
- Only “Front” or “-----” can be selected for the VIDEO 4 input selector.
- An input selector that’s been assigned to IN1 or IN2 in the “HDMI Video Setup” (page 43) can be set to HDMI here.

**4** Press the [SETUP] button. Setup closes.

**Note:**

- This procedure can also be performed on the AV receiver by using its [SETUP] button, arrow buttons, and [ENTER] button.

### Changing the Input Display

If you connect an **RI**-capable Onkyo MiniDisc recorder, CD recorder, or next generation HDD-compatible component, such as the Remote Interactive Dock, to the TAPE IN/OUT or VIDEO 3 IN jacks, for **RI** to work properly, you must change this setting. This setting can only be changed on the AV receiver.

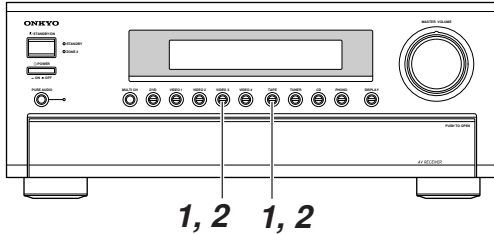

|                           |   |
|---------------------------|---|
| <p><b>1</b></p> <p>or</p> | <p>Press the [TAPE] or [VIDEO 3] input selector button so that “TAPE” or “VIDEO3” appears on the display.</p> <div style="border: 1px solid black; padding: 5px; margin: 5px 0;">TAPE</div> <div style="border: 1px solid black; padding: 5px; margin: 5px 0;">VIDEO3</div>   |
| <p><b>2</b></p> <p>or</p> | <p>Press and hold down the [TAPE] or [VIDEO 3] input selector button (about 3 seconds) to change the setting.</p> <p>Repeat this step to select MD, CDR, or HDD.</p> <p>For the TAPE input selector, the setting changes in this order:<br/>TAPE → MD → CDR → HDD →</p> <p>For the VIDEO 3 input selector, the setting changes in this order:<br/>VIDEO 3 → HDD → VIDEO 3 →</p> |

**Note:**

HDD can be selected for the TAPE input selector or VIDEO 3 input selector, but not both at the same time.

### Minimum Speaker Impedance

If you change this setting, you must run the automatic speaker setup again (see page 40).

If the impedance of any speaker is 4 ohms or more but less than 6, set the Minimum Speaker Impedance to 4 ohms.

**Note:**

Before you change this setting, turn down the volume.





|                 |   |
|-----------------|---|
| <p><b>1</b></p> | <p>Press the [RECEIVER] button, followed by the [SETUP] button. The main menu appears onscreen.</p>   |
| <p><b>2</b></p> | <p>Use the Up and Down [▲]/[▼] buttons to select “3. Speaker Setup,” and then press [ENTER]. The Speaker Setup menu appears.</p> <div style="border: 1px solid black; padding: 5px; margin: 5px 0;"> <p>3. Speaker Setup</p> <hr style="border: 0.5px dashed black;"/> <p>1. Speaker Impedance</p> <p>2. Speaker Configuration</p> <p>3. Speaker Distance</p> <p>4. Level Calibration</p> <p>5. THX Audio Setup</p> <p>6. Equalizer Settings</p> </div> |
| <p><b>3</b></p> | <p>Use the Up and Down [▲]/[▼] buttons to select “Speaker Impedance,” and then press [ENTER].</p>   |
| <p><b>4</b></p> | <p>Use the Left and Right [◀]/[▶] buttons to select:</p> <p><b>4 ohms:</b> Select if the impedance of any speaker is 4 ohms or more but less than 6.</p> <p><b>6 ohms:</b> Select if the impedances of all speakers are between 6 and 16 ohms.</p>  |
| <p><b>5</b></p> | <p>Press the [SETUP] button. Setup closes.</p>  |

**Notes:**

- This procedure can also be performed on the AV receiver by using its [SETUP] button, arrow buttons, and [ENTER] button.

## TV Format Setup (not North American models)

You must specify the TV system used in your area.





|   |   |
|---|---|
| <p><b>1</b></p>    | <p><b>Press the [RECEIVER] button, followed by the [SETUP] button.</b><br/>The main menu appears onscreen.</p>  |
| <p><b>2</b></p>    | <p><b>Use the Up and Down [▲]/[▼] buttons to select “8. Hardware Setup,” and then press [ENTER].</b><br/>The Hardware Setup menu appears.</p> <div style="border: 1px solid black; padding: 5px; margin: 10px 0;"> <pre> 8. Hardware Setup ----- a. PoweredZone2: NotActⓄⓄ b. TV Format      : AutoⓄⓄ c. AM Freq. Step: 9kHzⓄⓄ d. Remote ID     : 1ⓄⓄ                     </pre> </div> |
| <p><b>3</b></p>   | <p><b>Use the Up and Down [▲]/[▼] buttons to select “TV Format,” and then use the Left and Right [◀]/[▶] buttons to select:</b></p> <p><b>Auto:</b> Select this to automatically detect the TV system from the video input signals.</p> <p><b>NTSC:</b> Select if the TV system in your area is NTSC.</p> <p><b>PAL:</b> Select if the TV system in your area is PAL.</p>               |
| <p><b>4</b></p>  | <p><b>Press the [SETUP] button.</b><br/>Setup closes.</p>   |

**Note:**

- This procedure can also be performed on the AV receiver by using its [SETUP] button, arrow buttons, and [ENTER] button.

## AM Frequency Step Setup (on some models)

You must specify the AM frequency step used in your area. Note that when this setting is changed, all radio presets are deleted.

|   |   |
|---|---|
| <p><b>1</b></p>    | <p><b>Press the [RECEIVER] button, followed by the [SETUP] button.</b><br/>The main menu appears onscreen.</p>  |
| <p><b>2</b></p>    | <p><b>Use the Up and Down [▲]/[▼] buttons to select “8. Hardware Setup,” and then press [ENTER].</b><br/>The Hardware Setup menu appears.</p> <div style="border: 1px solid black; padding: 5px; margin: 10px 0;"> <pre> 8. Hardware Setup ----- a. PoweredZone2: NotActⓄⓄ b. TV Format      : AutoⓄⓄ c. AM Freq. Step: 9kHzⓄⓄ d. Remote ID     : 1ⓄⓄ                     </pre> </div> |
| <p><b>3</b></p>  | <p><b>Use the Up and Down [▲]/[▼] buttons to select “AM Freq. Step,” and then use the Left and Right [◀]/[▶] buttons to select:</b></p> <p><b>10 kHz:</b> Select if 10 kHz steps are used in your area.</p> <p><b>9 kHz:</b> Select if 9 kHz steps are used in your area.</p>   |
| <p><b>4</b></p>  | <p><b>Press the [SETUP] button.</b><br/>Setup closes.</p>   |

**Note:**

- This procedure can also be performed on the AV receiver by using its [SETUP] button, arrow buttons, and [ENTER] button.

# Playing Your AV Components

## Basic AV Receiver Operation

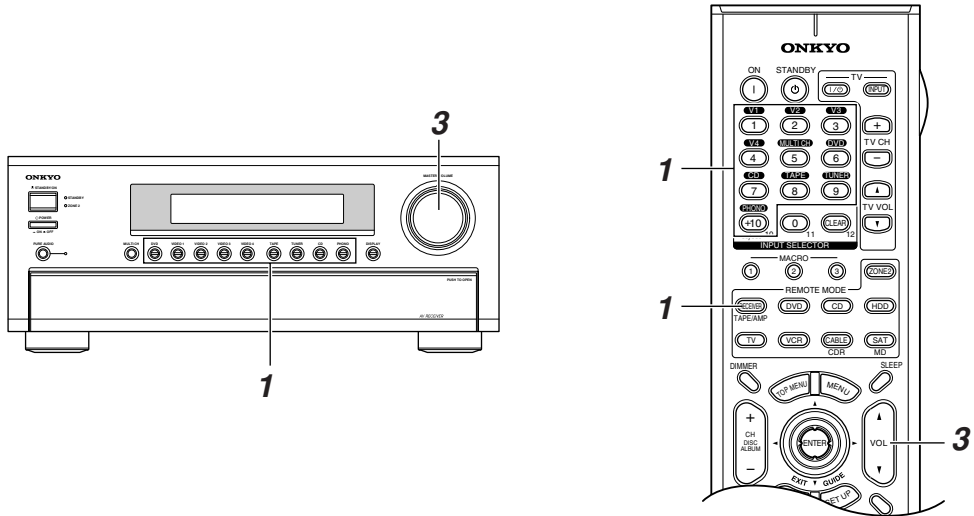

- 1**

**AV receiver**

**Remote controller**

**Use the AV receiver's input selector buttons to select the input source.**

**To select the input source with the remote controller, press the [RECEPTION] REMOTE MODE button, and then use the INPUT SELECTOR buttons.**

On the remote controller, the [V1], [V2], [V3], and [V4] buttons select the VIDEO 1, VIDEO 2, VIDEO 3, and VIDEO 4 input sources respectively.
- 2**

**Start playback on the source component.**

To watch a DVD or other video source, on your TV, select the video input that's connected to the AV receiver's COMPONENT VIDEO OUT, HDMI OUT, or MONITOR OUT.

On some DVD players, you may need to change the digital or HDMI audio output settings.
- 3**

**AV receiver**

**Remote controller**

**To adjust the volume, use the MASTER VOLUME control or the remote controller's [VOL] button.**

Since the AV receiver is designed for home theaters, it has a wide volume range for precise adjustment. The volume can be set to  $-\infty$  dB,  $-81$  dB,  $-80$  dB through  $+18$  dB.
- 4**

**Select a listening mode and enjoy!**

See "Using the Listening Modes" on page 60.



# Listening to the Radio

## Listening to AM/FM Stations

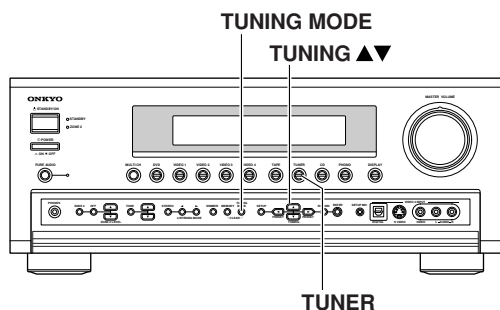

With the built-in tuner, you can enjoy AM and FM radio stations, and store your favorite stations as presets for easy selection.

**1** **TUNER**

Use the [TUNER] input selector button to select AM or FM. In this example, FM has been selected.

FM 87.5 MHz

Band      Frequency

(Actual display depends on country.)

## Tuning into AM/FM Radio Stations

### Auto Tuning Mode

**1** **TUNING MODE**

Press the [TUNING MODE] button so that the AUTO indicator appears on the display.

**2**

Press the TUNING Up or Down [▲]/[▼] button. Searching stops when a station is found.

When tuned into a station, the TUNED indicator appears. When tuned into a stereo FM station, the FM STEREO indicator also appears.

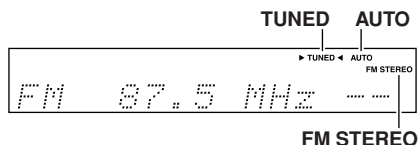

### Manual Tuning Mode

**1** **TUNING MODE**

Press the [TUNING MODE] button so that the AUTO indicator disappears from the display.

**2**

Press and hold the TUNING Up or Down [▲]/[▼] button. The frequency stops changing when you release the button. Press the buttons repeatedly to change the frequency one step at a time.

The North American model changes FM frequency in 0.2 MHz steps, 10 kHz steps for AM. For other models it's 0.05 MHz steps for FM and 9 kHz steps for AM. In Manual Tuning mode, FM stations will be in mono.

### Tuning into Weak FM Stereo Stations

If the signal from a stereo FM station is weak, it may be impossible to get good reception. In this case, switch to Manual Tuning mode and listen to the station in mono.

## Displaying AM/FM Radio Information

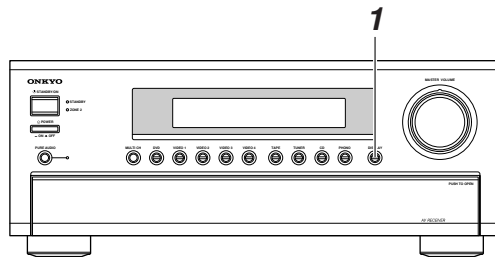

**1** **DISPLAY**

Press the [DISPLAY] button repeatedly to cycle through the available information.

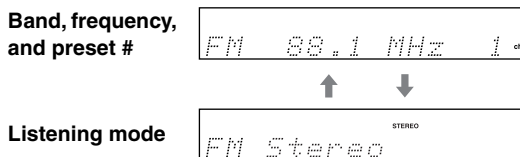

### Using RDS (European Model Only)

RDS only works with European models in areas where RDS broadcasts are available. When tuned to an RDS station, the RDS indicator appears.

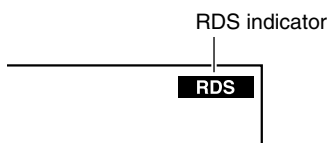

#### ■ What is RDS?

RDS stands for *Radio Data System* and is a method of transmitting data in FM radio signals. It was developed by the European Broadcasting Union (EBU) and is available in most European countries. Many FM stations use it these days. In addition to displaying text information, RDS can also help you find radio stations by type (e.g., news, sport, rock, etc.).

The AV receiver supports four types of RDS information:

#### **PS (Program Service)**

When tuned to an RDS station that's broadcasting PS information, the station's name will be displayed. Pressing the [DISPLAY] button will display the frequency for 3 seconds.

#### **RT (Radio Text)**

When tuned to an RDS station that's broadcasting text information, the text will be shown on the display (see page 51).

#### **PTY (Program Type)**

This allows you to search RDS radio stations by type (see page 51).

#### **TP (Traffic Program)**

This allows you to search for RDS radio stations that broadcast traffic information (see page 51).

#### **Notes:**

- In some cases, the text characters displayed on the AV receiver may not be identical to those broadcast by the radio station. Also, unexpected characters may be displayed when unsupported characters are received. This is not a malfunction.
- If the signal from an RDS station is weak, RDS data may be displayed intermittently or not at all.

### RDS Program Types (PTY)

| Type                     | Display  |
|--------------------------|----------|
| None                     | NONE     |
| News reports             | NEWS     |
| Current affairs          | AFFAIRS  |
| Information              | INFO     |
| Sport                    | SPORT    |
| Education                | EDUCATE  |
| Drama                    | DRAMA    |
| Culture                  | CULTURE  |
| Science and technology   | SCIENCE  |
| Varied                   | VARIED   |
| Pop music                | POP M    |
| Rock music               | ROCK M   |
| Middle of the road music | EASY M   |
| Light classics           | LIGHT M  |
| Serious classics         | CLASSICS |
| Other music              | OTHER M  |
| Weather                  | WEATHER  |
| Finance                  | FINANCE  |
| Children's programmes    | CHILDREN |
| Social affairs           | SOCIAL   |
| Religion                 | RELIGION |
| Phone in                 | PHONE IN |
| Travel                   | TRAVEL   |
| Leisure                  | LEISURE  |
| Jazz music               | JAZZ     |
| Country music            | COUNTRY  |
| National music           | NATION M |
| Oldies music             | OLDIES   |
| Folk music               | FOLK M   |
| Documentary              | DOCUMENT |
| Alarm test               | TEST     |
| Alarm                    | ALARM    |

## Listening to the Radio—Continued

### Displaying Radio Text (RT)

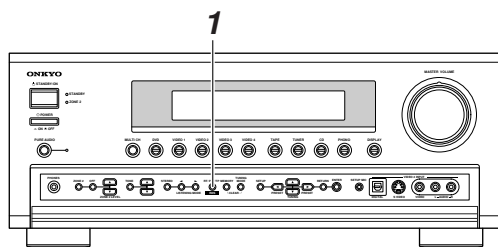

When tuned to an RDS station that's broadcasting text information, the text can be displayed.

**1**



**Press the [RT/PTY/TP] button once.**

The RT information scrolls across the display.

#### Notes:

- The message “Waiting” may appear while the AV receiver waits for the RT information.
- If the message “No Text Data” appears on the display, no RT information is available.

### Finding Stations by Type (PTY)

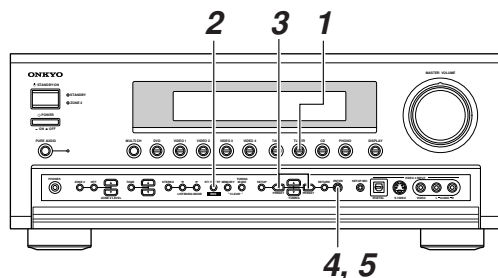

You can search for radio stations by type.

**1**



**Use the [TUNER] input selector button to select FM.**

**2**



**Press the [RT/PTY/TP] button twice.**

The current program type appears on the display.

**3**



**Use the PRESET [◀]/[▶] buttons to select the type of program you want.**

See the table on page 50.

**4**



**To start the search, press [ENTER].**

The AV receiver searches until it finds a station of the type you specified, at which point it stops briefly before continuing with the search.

**5**



**When a station you want to listen to is found, press [ENTER].**

If no stations are found, the message “Not Found” appears.

### Listening to Traffic News (TP)

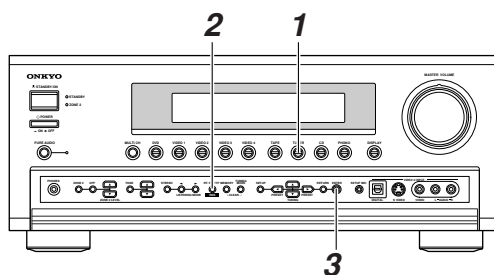

You can search for stations that broadcast traffic news.

**1**



**Use the [TUNER] input selector button to select FM.**

**2**



**Press the [RT/PTY/TP] button three times.**

If the current radio station is broadcasting TP (Traffic Program), “[TP]” will appear on the display, and traffic news will be heard as and when it's broadcast. If “TP” without square brackets appears, this means that the station is not broadcasting TP.

**3**



**To locate a station that is broadcasting TP, press [ENTER].**

The AV receiver searches until it finds a station that's broadcasting TP. If no stations are found, the message “Not Found” appears.

**Listening to XM Satellite Radio®  
(North American Models Only)**

**Important XM Radio Information**

XM Satellite Radio offers an extraordinary variety of commercial-free music, plus the best in sports, news, talk and entertainment. XM is broadcast in superior digital audio from coast to coast. From rock to reggae, from classical to hip hop, XM has something for every music fan. XM’s dedication to playing the richest selection of music is matched by its passion for live sporting events, talk radio, up-to-the-minute news, stand-up comedy, children’s programming, and much more. For U.S. customers, information about XM Satellite Radio is available online at [www.xmradio.com](http://www.xmradio.com). For Canadian customers, information about XM Canada is online at [www.xmradio.ca](http://www.xmradio.ca).

**Note:**

Hardware and required monthly subscription sold separately. Other fees and taxes, including a one-time activation fee may apply. Subscription fee is consumer only. All fees and programming subject to change. Channels with frequent explicit language are indicated with an XL. Channel blocking is available for XM radio receivers by calling 1-800-XMRADIO (US residents) and 1-877-GET-XMSR (Canadian residents).

For a full listing of the XM commercial-free channels and advertising-supported channels, visit [lineup.xmradio.com](http://lineup.xmradio.com) (US residents) or [xmradio.ca](http://xmradio.ca) (Canadian residents).

Subscriptions subject to Customer Agreement available at [xmradio.com](http://xmradio.com) (US residents) and [xmradio.ca](http://xmradio.ca) (Canadian residents). Only available in the 48 contiguous United States and Canada. ©2006 XM Satellite Radio Inc. All rights reserved. All other trademarks are the property of their respective owners.

**A warning against reverse engineering:**

It is prohibited to copy, decompile, disassemble, reverse engineer, or manipulate any technology incorporated in receivers compatible with the XM Satellite Radio system. Furthermore, the AMBE® voice compression software included in this product is protected by intellectual property rights including patent rights, copyrights, and trade secrets of Digital Voice Systems, Inc. The user of this or any other software contained in an XM Radio is explicitly prohibited from attempting to copy, decompile, reverse engineer, or disassemble the object code, or in any other way convert the object code into human-readable form. The software is licensed solely for use within this product.

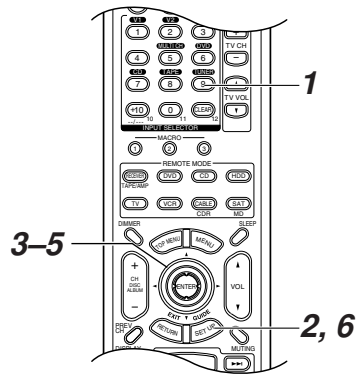

**Setting the Satellite Radio Mode**

Before you can listen to XM Satellite Radio, you must set the Satellite Radio mode to XM.

|                 |  |
|-----------------|--|
| <p><b>1</b></p> | <p><b>Press the [TUNER] input selector button.</b></p>   |
| <p><b>2</b></p> | <p><b>Press the [SETUP] button.</b></p>  |
| <p><b>3</b></p> | <p><b>Use the Up and Down [▲]/[▼] buttons to select “4.Input Setup,” and then press [ENTER].</b></p>   |
| <p><b>4</b></p> | <p><b>Use the Up and Down [▲]/[▼] buttons to select “2.SAT Radio-Mode,” and then press [ENTER].</b></p>  |
| <p><b>5</b></p> | <p><b>Use the Left and Right [◀]/[▶] buttons to select “XM.”</b></p> <p><b>None:</b> Select if you are not using satellite radio.<br/> <b>XM:</b> Select to use XM satellite radio.</p> <div style="border: 1px solid black; padding: 5px; margin-top: 10px;"> <pre> 4-2. SAT RadioMode -----TUNER----- a. SAT RadioMode       : XM 06                     </pre> </div> |
| <p><b>6</b></p> | <p><b>Press the [SETUP] button.</b></p>  |

## Listening to the Radio—Continued

### Connecting the XM Mini-Tuner and Home Dock

To receive XM Satellite Radio, you need an XM Mini-Tuner and Home Dock, which includes a home antenna. These are sold separately. For connection information, refer to the instruction manual supplied with the XM Mini-Tuner and Home Dock.

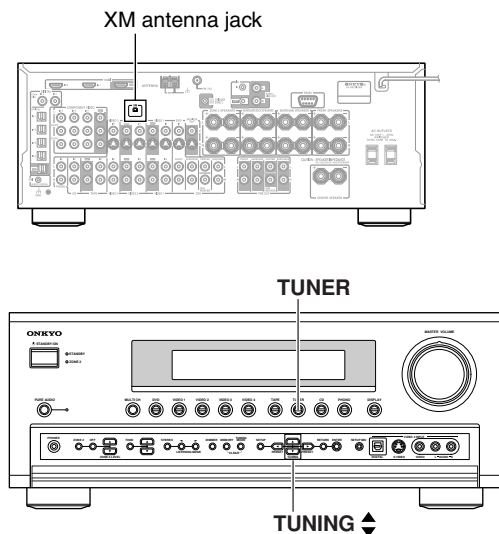

### Selecting XM Satellite Radio

1

TUNER



**Press the [TUNER] input selector button repeatedly to select XM.**

If “CHECK ANTENNA” appears on the display, make sure the XM Mini-Tuner is connected properly.

### Signing Up for XM Satellite Radio

Once you have installed the XM Mini-Tuner and Home Dock, you are ready to subscribe to XM Satellite Radio. You’ll need a major credit card and your XM Radio ID. There are three places you can find your 8-character XM Radio ID:

1. On the XM Mini-Tuner
2. On the XM Mini-Tuner packaging
3. On XM Channel 0, as explained below

1

**Use the TUNING Up and Down [▲]/[▼] buttons to select RADIO ID.**

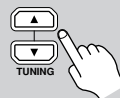

Your XM Radio ID number is displayed. Write it below for reference.

ID \_\_\_\_\_

2

**To sign up, go to:**  
<http://activate.xmradio.com>  
**Or call: 1-800-967-2346**  
**For XM Canada, go to:**  
<http://xmradio.ca>  
**Or call: 1-877-438-9677**

#### Notes:

- RADIO ID cannot be selected in Category Search mode. You must select Channel Search mode (see page 54).
- The following letters are not used in XM Satellite Radio IDs: I, O, S, F.
- XM Satellite Radio will transmit a special signal to your AV receiver to activate the full channel lineup. Activation normally takes between 10 and 15 minutes, but during busy peak periods, you may need to leave the AV receiver turned on for up to an hour.

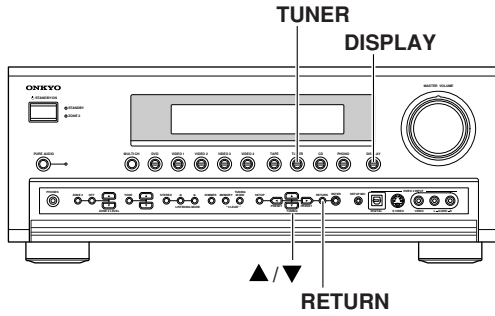
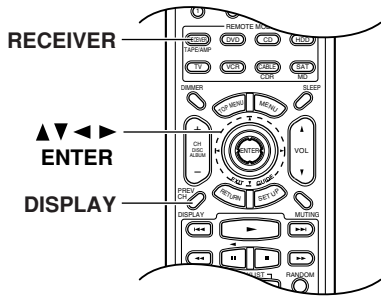

## Selecting XM Radio Channels

There are two ways to select XM radio channels:

- **Channel Search mode:** select any channel.
- **Category Search mode:** select channels by category.

### Note:

You can't select Channel Search or Category Search mode, while the Tuning Arrow indicators are flashing, as tuning is in progress.

### ■ Channel Search Mode

|          |   |
|----------|---|
| <b>1</b> | <p>Press the [RECEPTOR] button, followed by the [ENTER] button to select Channel Search mode.</p>                                     |
|          |   |
| <b>2</b> | <p>Use the Up and Down []/[] buttons to select a channel. You can also use the Left and Right []/[] buttons to select a category.</p> |

### ■ Category Search Mode

|          |   |
|----------|---|
| <b>1</b> | <p>Press the [RECEPTOR] button, followed by the [ENTER] button to select Category Search mode.</p>  |
|          |   |
| <b>2</b> | <p>Use the Left and Right []/[] buttons to select a category, and use the Up and Down []/[] buttons to select a channel in that category.</p> |

## Selecting XM Channels from the Front Panel:

|          |  |
|----------|--|
| <b>1</b> | <p>Press the [TUNING MODE] button to select Channel Search or Category Search mode.</p>  |
| <b>2</b> | <p>Press the [ENTER] button repeatedly to select a category.</p>   |
| <b>3</b> | <p>Use the TUNING Up and Down []/[] buttons to select a channel. In Channel Search mode, you can select any channel. In Category Search mode, you can only select channels from the currently selected category.</p> |

## Selecting the Previous Channel:

|                          |  |
|--------------------------|--|
| <b>1</b>                 | <p>To listen to the previously selected XM channel, press the [RETURN] button.</p> |
| <p>Remote controller</p> |  |

## Displaying XM Radio Information

Press the [DISPLAY] button repeatedly to cycle through the available information.

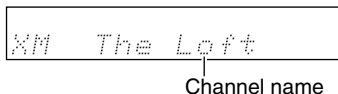

The following information is displayed:

1. Channel name
2. Channel number & Preset number
3. Category name (CAT)
4. Artist name (NAME)
5. Song title (TITL)
6. Listening mode

**Note:**

- If the category, artist, or song title is not available, “- - -” will be displayed instead.

### ■ Displaying XM Radio Information on Your TV

When you select a different XM channel, or the artist or song title changes, the following information is displayed on your TV for 3 seconds.

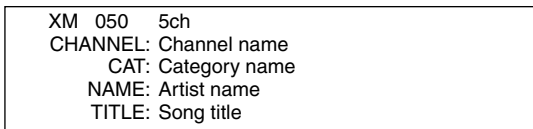

**Tip:**

You can display this information at anytime by pressing the [DISPLAY] button.

### ■ XM Radio Messages

The following messages may appear while using XM radio.

**CHECK ANTENNA**

The XM Mini-Tuner and Home Dock is not connected properly. Check the connection.

**UPDATING**

The XM user encryption code is being updated. Please wait.

**NO SIGNAL**

The signal is too weak. Check the XM Mini-Tuner and/or antenna connection and reposition it for the best reception.

**LOADING**

The main unit is tuning or decoding audio or text data. Please wait.

**OFF AIR**

The XM channel you selected is not currently broadcasting. Select another channel.

## Positioning the XM Antenna



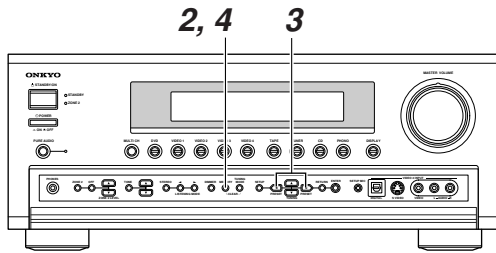

You can check the signal strength of the XM Radio signal and adjust the position of the XM antenna accordingly.

|  |  |
|--|--|
|  | <p><b>1</b> Press the [RECEIVER] button, followed by the [SETUP] button.</p>   |
|  | <p><b>2</b> Use the Up and Down [▲]/[▼] buttons to select “4. Input Setup,” and then press [ENTER].</p>  |
|  | <p><b>3</b> Use the Up and Down [▲]/[▼] buttons to select “3. XM Antenna Aiming,” and then press [ENTER].</p>  |
|  | <p><b>4</b> Adjust the position of the XM antenna so that the Satellite signal strength bar is as long as possible.</p> <div style="border: 1px solid black; padding: 5px; margin: 10px 0;"> <pre> 4-3.Antenna Aiming -----TUNER-----  a.Satellite [     .....]  b.Terrestrial [.....]                     </pre> </div> <p>If you can't receive a “Satellite” signal, adjust your XM antenna so that the “Terrestrial” signal strength bar is as long as possible. Terrestrial signals are only available in certain areas. So long as the signal strength is good, you can enjoy XM Radio by using either satellite or terrestrial reception. Press the Down [▼] button to display the “Terrestrial” signal strength bar on the display.</p> |
|  | <p><b>5</b> When you've finished, press the [SETUP] button. Setup closes.</p>  |

**Presetting AM, FM, and XM Stations**

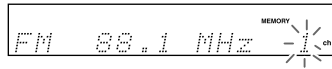



You can store a combination of up to 40 of your favorite AM, FM, and XM radio stations.

- |          |  |
|----------|--|
| <b>1</b> | <p><b>Tune into the AM, FM, or XM station you want to store as a preset.</b></p>   |
| <b>2</b> | <p><b>Press the [MEMORY] button.</b><br/>The MEMORY indicator appears and the preset number flashes.</p>    |
| <b>3</b> | <p><b>While the MEMORY indicator is displayed (about 8 seconds), use the PRESET [◀]/[▶] buttons to select a preset from 1 through 40.</b></p>   |
| <b>4</b> | <p><b>Press the [MEMORY] button again to store the station.</b><br/>The station is stored and the preset number stops flashing.<br/>Repeat this procedure for all of your favorite stations.</p>    |

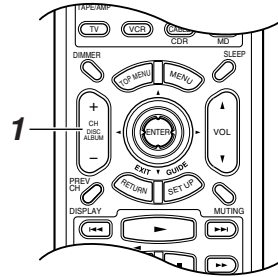
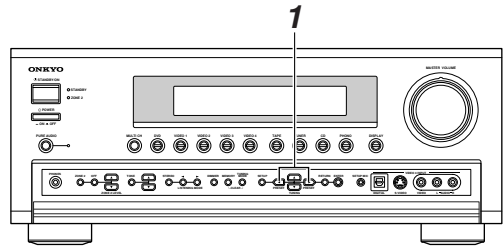
**Selecting Presets**

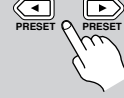

- |          |   |
|----------|---|
| <b>1</b> | <p><b>To select a preset, use the PRE-SET [◀]/[▶] buttons, or the remote controller's CH [+/-] button.</b></p>   |
|----------|---|

**Deleting Presets**

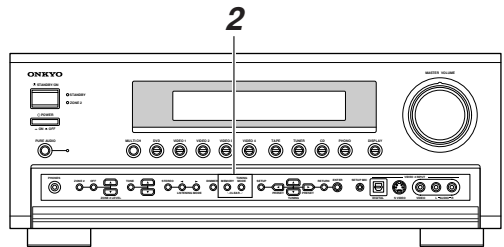

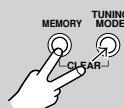
- |          |   |
|----------|---|
| <b>1</b> | <p><b>Select the preset that you want to delete.</b><br/>See the previous section.</p>  |
| <b>2</b> | <p><b>While holding down the [MEMORY] button, press the [TUNING MODE] button.</b><br/>The preset is deleted and its number disappears from the display.</p>  |



# Using the Multichannel DVD Input

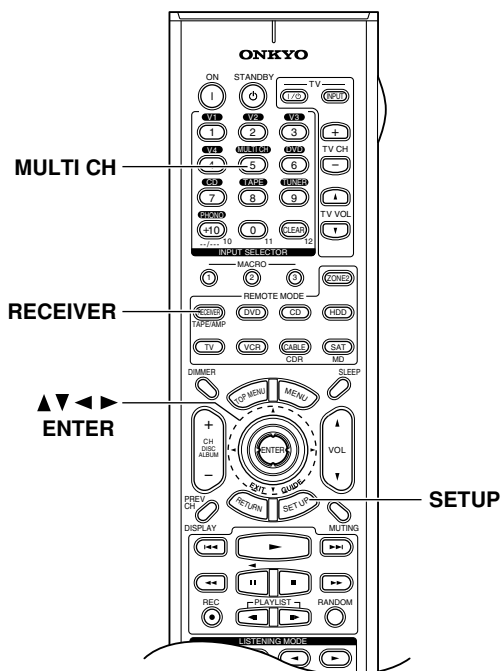

## Using the Multichannel DVD Input

The multichannel DVD input is for connecting a component with a 5.1/7.1-channel analog audio output, such as a DVD player, DVD-Audio/SACD-capable player, or an MPEG decoder. See page 28 for hookup information.



Press the [RECEIVER] REMOTE MODE button, followed by the [MULTI CH] button.

The MULTI CH indicator appears on the display.

Audio from the multichannel DVD input will now be used for the DVD input source.

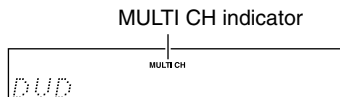

## Multichannel DVD Input Settings



**1** While the DVD input is selected, press the [RECEIVER] REMOTE MODE button, followed by the [SETUP] button. The main menu appears onscreen.

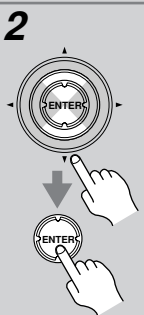

**2** Use the Up and Down [▲]/[▼] buttons to select "4. Input Setup," and then press [ENTER].

Use the Up and Down [▲]/[▼] buttons to select "2. MULTICH," and then press [ENTER]. The Multichannel Analog menu appears.

```
4-2. MULTICH
-----DVD-----
a. Input Channel: 5.1ch
b. Subwoofer Sensitivity
   : 0dB
```



**3** Use the Up and Down [▲]/[▼] buttons to select the settings, and use the Left and Right [◀]/[▶] buttons to change them. The settings are explained below.



**4** Press the [SETUP] button. Setup closes.

## Input Channel

If you've connected a 7.1-channel audio output to the multichannel DVD input, select 7.1ch. If you've connected a 5.1-channel audio output, select 5.1ch.

## Subwoofer Sensitivity

Some DVD players output the LFE channel from their subwoofer output at 15 dB higher than normal. You can change the subwoofer sensitivity to match your DVD player. Note that this setting only affects signals connected to the SUBWOOFER input jack of the multichannel DVD input.

You can select 0 dB, +5 dB, +10 dB, or +15 dB.

If you find that your subwoofer is too loud, try the +10 dB or +15 dB setting.

# Common Functions

This section explains functions that can be used with any input source.

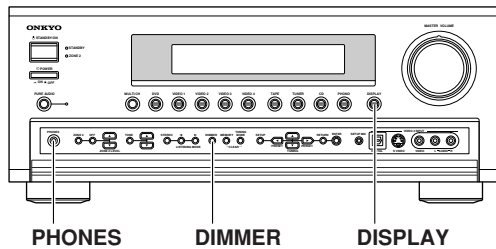
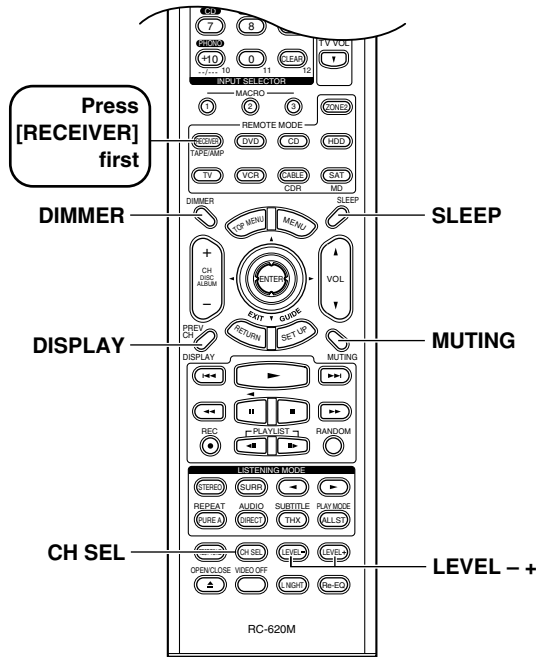

## Setting the Display Brightness

You can adjust the brightness of the display.

|   |   |
|---|---|
| <p><b>Remote controller</b></p> <p>DIMMER</p> | <p><b>Press the remote controller's [DIMMER] button repeatedly to select:</b></p> <ul style="list-style-type: none"> <li>• Normal + VOLUME light on.</li> <li>• Normal + VOLUME light off.</li> <li>• Dim + VOLUME light off.</li> <li>• Dimmer + VOLUME light off.</li> </ul> <p>You can also use the AV receiver's [DIMMER] button (not European models).</p> |
| <p><b>AV receiver</b></p> <p>DIMMER</p>       |   |

## Adjusting Speaker Levels

You can adjust the volume of each speaker while listening to an input source. These temporary adjustments are cancelled when the AV receiver is set to Standby.

**1**

Use the remote controller's [CH SEL] button to select each speaker, and use the [LEVEL-] and [LEVEL+] buttons to adjust the volume.

You can adjust the volume of each speaker from -12 dB to +12 dB (-15 dB to +12 dB for the subwoofer).

### Notes:

- You cannot use this function while the AV receiver is muted.
- Speakers that are set to No or None in the Speaker Configuration cannot be adjusted.

### Headphones

While a pair of headphones is connected, you can adjust the volume of each headphone speaker, from -12 dB to +12 dB each.

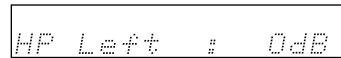

- These settings are stored when the AV receiver is set to Standby.

## Muting the AV Receiver

You can temporarily mute the output of the AV receiver.

Press the remote controller's [MUTING] button.

The output is muted and the MUTING indicator flashes on the display.

**To unmute the AV receiver,** press the remote controller's [MUTING] button again, or adjust the volume. The output is unmuted and the MUTING indicator goes off. Muting is cancelled when the AV receiver is set to Standby.

### Tip:

You can choose how much the output is muted by using the Muting Level preference (see page 77).

### Using the Sleep Timer

With the sleep timer, you can set the AV receiver so that it turns off automatically after a specified period.



**Press the remote controller's [SLEEP] button repeatedly to select the required sleep time.**

You can set the sleep time from 90 to 10 minutes in 10 minute steps.

The SLEEP indicator appears on the display when the sleep timer has been set, as shown. The specified sleep time appears on the display for about 5 seconds, then the previous display reappears.

SLEEP indicator

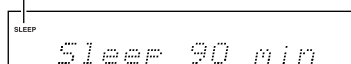

**To cancel the sleep timer,** press the [SLEEP] button repeatedly until the SLEEP indicator disappears.

**To check the remaining sleep time,** press the [SLEEP] button. Note that if you press the [SLEEP] button while the sleep time is being displayed, you'll shorten the sleep time by 10 minutes.

### Using Headphones

For private listening, you can connect a pair of stereo headphones (1/4-inch phone plug) to the AV receiver's PHONES jack.

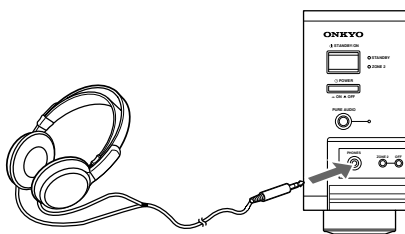

#### Notes:

- Always turn down the volume before connecting your headphones.
- The speakers are turned off while the headphones plug is inserted in the PHONES jack. (The Zone 2 speakers are unaffected.)
- When you connect a pair of headphones, the listening mode is set to Stereo, unless it was set to Pure Audio, Mono, Stereo, or Direct, in which case it stays the same.

### Displaying Source Information

You can display various information about the current input source as follows.

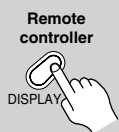

**Press the [DISPLAY] button repeatedly to cycle through the available information.**



The following information can typically be displayed:

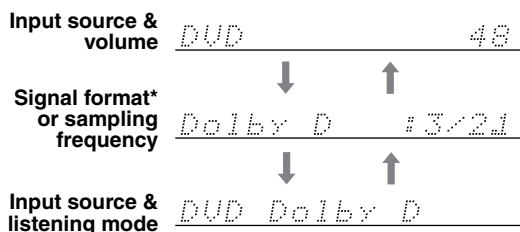

\*If the input signal is analog, no format information is displayed. If the input signal is PCM, the sampling frequency is displayed. If the input signal is digital but not PCM, the signal format is displayed.

If the input signal is multichannel PCM, the sampling frequency and signal format will be displayed. Information is displayed for about 3 seconds, then the previous display reappears.

#### Interpreting Surround Channel Information

$$\frac{3}{A} \frac{21}{B \ C}$$

- A: The number of front channels (front left, front right, and center).
- B: The number of surround channels (surround left and surround right). If there's surround back channel information, this number will be 3.
- C: LFE channel for subwoofer (1 means yes).

# Using the Listening Modes

## Selecting the Listening Modes

For a description of each listening mode, see “About the Listening Modes” on page 62.

- The Dolby Digital and DTS listening modes can only be selected if your DVD player is connected to the AV receiver with a digital audio connection (coaxial, optical, or HDMI).
- Listening mode availability depends on the format of the current input signal.
- While a pair of headphones is connected, you can only select the Pure Audio, Mono, Direct, or Stereo listening mode.

## Selecting on the AV Receiver

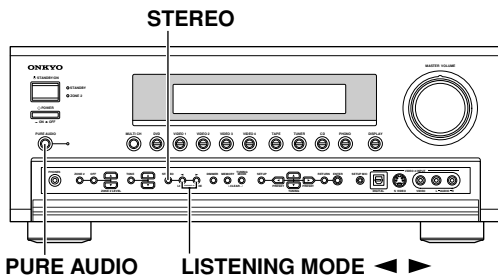

- **[PURE AUDIO] button**  
This button selects the Pure Audio listening mode. When this mode is selected, the AV receiver’s display is turned off and only the HDMI OUT outputs video signals. Pressing this button again will select the previous listening mode.
- **[STEREO] button**  
This button selects the Stereo listening mode.
- **LISTENING MODE [◀/▶] buttons**  
Pressing these buttons repeatedly cycles through all of the listening modes that can be used with the current input source.

## Selecting with the Remote Controller

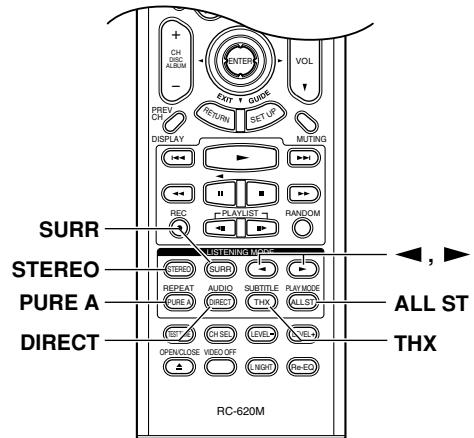

- **[STEREO] button**  
This button selects the Stereo listening mode.
- **[SURREAL] button**  
This button selects the Dolby Digital and DTS listening modes.
- **LISTENING MODE [◀/▶] buttons**  
Pressing these buttons repeatedly cycles through all of the listening modes that can be used with the current input source.
- **[PURE A] button**  
This button selects the Pure Audio listening mode. When this mode is selected, the AV receiver’s display is turned off and only the HDMI OUT outputs video signals.
- **[DIRECT] button**  
This button selects the Direct listening mode.
- **[THX] button**  
This button selects the THX listening modes.
- **[ALL ST] button**  
This button selects the All Channel Stereo listening mode.

## Using the Listening Modes—Continued

The following table shows which listening modes can be used with each input signal format.

| Source format   |  | Analog,<br>PCM <sup>*1</sup>           | Dolby Digital  |     |          |       | DTS/DTS 96/24 <sup>*2</sup> |     |                 |        | Multich analog,<br>Multich<br>PCM <sup>*3</sup> |
|---|--|--|----------------|-----|----------|-------|-----------------------------|-----|-----------------|--------|---|
|   |  |  | 3/2.1<br>2/2.1 | 2/0 | 1/0, 1+1 | Other | 3/2.1<br>2/2.1              | 2/0 | DTS-ES          |        |   |
|   |  |  |                |     |          |       |                             |     | Discrete        | Matrix |   |
| Listening mode  |  | CD, TV,<br>radio,<br>cassette,<br>etc. | DVD, DTV, etc. |     |          |       | DVD, CD, etc.               |     |                 |        | DVD   |
| Pure Audio<br>Direct<br>Stereo  |  | ✓                                      | ✓              | ✓   | ✓        | ✓     | ✓                           | ✓   | ✓               | ✓      | ✓   |
| Mono  |  | ✓                                      | ✓              | ✓   | ✓        | ✓     | ✓                           | ✓   | ✓               |        |   |
| Multich   |  |  |                |     |          |       |                             |     |                 |        | ✓   |
| PLIIx Movie/Music/Game <sup>*4</sup><br>Neo:6 Cinema<br>Neo:6 Music <sup>*5</sup> |  | ✓                                      |                | ✓   |          |       |                             | ✓   |                 |        |   |
| Dolby   | Dolby D  |  | ✓              |     |          | ✓     |                             |     |                 |        |   |
|   | Dolby D EX<br>Dolby D+PLIIx Music  |  | ✓              |     |          |       |                             |     |                 |        |   |
|   | Dolby D+PLIIx Movie  |  | ✓              |     |          |       |                             |     |                 |        |   |
|   |  |  |                |     |          |       |                             |     |                 |        |   |
| DTS   | DTS, DTS 96/24   |  |                |     |          | ✓     |                             |     | ✓ <sup>*6</sup> |        |   |
|   | DTS-ES Discrete  |  |                |     |          |       |                             | ✓   |                 |        |   |
|   | DTS-ES Matrix  |  |                |     |          |       |                             |     | ✓               |        |   |
|   | DTS+Neo:6<br>DTS+Dolby EX<br>DTS+PLIIx Music   |  |                |     |          | ✓     |                             |     |                 |        |   |
|   | DTS+PLIIx Movie  |  |                |     |          | ✓     |                             |     |                 |        |   |
| THX <sup>*5</sup>   | THX Cinema   | ✓                                      | ✓              | ✓   | ✓        | ✓     | ✓                           | ✓   | ✓               |        |   |
|   | THX Surround EX  |  | ✓              |     |          | ✓     |                             |     |                 |        |   |
|   | THX Select2 Cinema<br>THX Music mode   |  | ✓              |     |          | ✓     |                             |     |                 |        |   |
|   | THX Games mode   | ✓                                      | ✓              | ✓   | ✓        | ✓     | ✓                           | ✓   | ✓               |        |   |
| Onkyo<br>Original<br>DSP  | Mono Movie<br>Orchestra<br>Unplugged<br>Studio-Mix<br>TV Logic<br>All Ch Stereo<br>Full Mono <sup>*5</sup> | ✓                                      | ✓              | ✓   | ✓        | ✓     | ✓                           | ✓   | ✓               |        |   |

\*1. In the Pure Audio and Direct listening modes, 32 kHz, 44.1 kHz, and 48 kHz PCM is processed at 64 kHz, 88.2 kHz, and 96 kHz respectively. In listening modes other than Pure Audio, Direct, and Stereo, 96 kHz PCM is processed at 48 kHz.

\*2. In listening modes other than Pure Audio, Direct, Stereo, and DTS 96/24, DTS 96/24 sources are processed as normal DTS.

\*3. The Multich listening mode cannot be used with 176.4/192 kHz DTS sources connected to an HDMI IN.

\*4. If the Surr Back parameter is set to None, or the ZONE 2 SPEAKERS terminals are being used, normal Pro Logic II is used.

\*5. Available only when surround speakers are connected.

\*6. If the Surr Back setting is set to None, or the ZONE 2 SPEAKERS terminals are being used, normal DTS is used.

 : Only available on 6.1/7.1-channel playback systems. Not available while the ZONE 2 SPEAKERS terminals are being used.

 : Only available on 7.1-channel playback systems. Not available while the ZONE 2 SPEAKERS terminals are being used.

**Tip:** To check the format of the digital input signal, see “Displaying Source Information” on page 59.

### About the Listening Modes

The AV receiver's listening modes can transform your listening room into a movie theater or concert hall, with high fidelity and stunning surround sound.

#### Pure Audio

In this mode, the display and video circuitry are turned off, minimizing possible noise sources for the ultimate in high-fidelity reproduction. (As the video circuitry is turned off, only the HDMI OUT outputs video signals.)

#### Direct

In this mode, audio from the input source is output directly with minimal processing, providing high-fidelity reproduction. All of the source's audio channels are output as they are.

#### Stereo

Sound is output by the front left and right speakers.

#### Mono

Use this mode when watching an old movie with a mono soundtrack, or use it with the foreign language soundtracks recorded in the left and right channels of some movies. It can also be used with DVDs or other sources containing multiplexed audio, such as karaoke DVDs.

#### Dolby Pro Logic IIx

This mode expands any 2-channel source for 7.1-channel playback. It provides a very natural and seamless surround-sound experience that fully envelops the listener. As well as music and movies, video games can also benefit from the dramatic spatial effects and vivid imaging. If you're not using any surround back speakers, **Dolby Pro Logic II** will be used instead of Dolby Pro Logic IIx.

- **PLIIx Movie**

Use this mode with any stereo or Dolby Surround (Pro Logic) movie (e.g., TV, DVD, VHS).

- **PLIIx Music**

Use this mode with any stereo or Dolby Surround (Pro Logic) music source (e.g., CD, radio, cassette, TV, VHS, DVD).



- **PLIIx Game**

Use this mode with video games, especially those that bear the Dolby Pro Logic II logo.

#### Dolby Digital

Use this mode with DVDs that bear the  and Dolby Digital TV broadcasts. This is the most common digital surround-sound format, and it'll put you right in the middle of the action, just like being in a movie theater or concert hall.

#### Dolby Digital EX, DTS+Dolby EX

These modes expand 5.1-channel Dolby Digital and DTS sources for 6.1/7.1-channel playback. They're especially suited to Dolby  and DTS  soundtracks that include a matrix-encoded surround back channel. The additional channel adds an extra dimension and provides an enveloping surround sound experience, perfect for rotating

and fly-by sound effects. Use them with DVDs that bear the Dolby Digital or DTS logo.

#### Dolby Digital+PLIIx Music, DTS+PLIIx Music

These modes use the Pro Logic IIx Music mode to expand 5.1-channel Dolby Digital and DTS sources for 6.1/7.1-channel playback. Use them with Dolby Digital or DTS 5.1 music sources (e.g., DVD and Dolby Digital TV broadcasts).



#### Dolby Digital+PLIIx Movie, DTS+PLIIx Movie

These modes use the Pro Logic IIx Movie mode to expand 5.1-channel Dolby Digital and DTS sources for 7.1-channel playback. Use them with Dolby Digital and DTS 5.1 movies (e.g., DVD and select digital TV broadcasts).



#### DTS

The DTS digital surround-sound format supports up to 5.1 discrete channels and uses less compression for high-fidelity reproduction. Use it with DVDs and CDs that bear the DTS logo.



#### DTS 96/24

This mode is for use with DTS 96/24 sources. This is high-resolution DTS with a 96 kHz sampling rate and 24-bit resolution, providing superior fidelity. Use it with DVDs that bear the DTS 96/24 logo.



#### DTS-ES Discrete

This mode is for use with DTS-ES Discrete soundtracks that use a discrete surround-back channel for *true* 6.1/7.1-channel playback. The seven totally separate audio channels provide better spatial imaging and 360-degree sound localization, perfect for sounds that pan across the surround channels. Use it with DVDs that bear the DTS-ES logo, especially those with a DTS-ES Discrete soundtrack.



#### DTS-ES Matrix

This mode is for use with DTS-ES Matrix soundtracks that use a matrix-encoded back-channel for 6.1/7.1-channel playback. Use it with DVDs that bear the DTS-ES logo.



#### DTS NEO:6

This mode expands any 2-channel source for 6.1-channel playback. It uses six full-bandwidth channels of matrix decoding for matrix-encoded material, providing a very natural and seamless surround sound experience that fully envelops the listener.

- **NEO:6 Cinema**

Use this mode with any stereo movie (e.g., TV, DVD, VHS).

- **NEO:6 Music**

Use this mode with any stereo music source (e.g., CD, radio, cassette, TV, VHS, DVD).

### DTS+Neo:6

This mode uses Neo:6 to expand 5.1-channel DTS sources for 6.1/7.1-channel playback. Use it with DVDs that bear the DTS logo and feature a 5.1-channel soundtrack.



### THX

Founded by George Lucas, THX develops stringent standards that ensure movies are reproduced in movie theaters and home theaters just as the director intended.

- **THX Cinema**

This mode is for watching movies, which are typically recorded and edited on the assumption that they will be played in a sizable place like a movie theater. It carefully optimizes the tonal and spatial characteristics of the soundtrack for reproduction in the smaller home-theater environment. It can be used with 2-channel sources processed with other formats, and multichannel sources. Surround back speaker output depends on the source material and the selected listening mode.

- **THX Select2 Cinema**

This mode expands Dolby Digital and DTS 5.1-channel sources for 7.1-channel playback. It does this by analyzing the composition of the surround source, optimizing the ambient and directional sounds to produce the surround back channel output. This is a new and improved mode especially for home theater use.

- **THX Music Mode**

This mode is designed for use with music. It expands Dolby Digital and DTS 5.1-channel sources for 7.1-channel playback.

- **THX Games Mode**

This mode is designed for use with video games.

- **THX Surround EX**

This mode expands Dolby Digital and DTS 5.1-channel sources for 6.1/7.1-channel playback. It's especially suited to Dolby Digital EX sources. THX Surround EX, also known as Dolby Digital Surround EX, is a joint development between Dolby Laboratories and THX Ltd.

## Onkyo Original DSP Modes

---

### Mono Movie

This mode is suitable for old movies and other mono sources. The center speaker outputs the sound as it is, while reverb is applied to the sound output by the other speakers, giving presence to even mono material.

### Orchestra

Suitable for classical or operatic music, this mode emphasizes the surround channels in order to widen the stereo image and simulates the natural reverberation of a large hall.

### Unplugged

Suitable for acoustic instruments, vocals, and jazz, this mode emphasizes the front stereo image, giving the impression of being right in front of the stage.

### Studio-Mix

Suitable for rock or pop music, listening to music in this mode creates a lively sound field with a powerful acoustic image, like being at a club or rock concert.

### TV Logic

This mode adds realistic acoustics to TV shows produced in a TV studio, surround effects to the entire sound, and clarity to voices.

### All Ch Stereo

Ideal for background music, this mode fills the entire listening area with stereo sound from the front, surround, and surround back speakers.

### Full Mono

In this mode, all speakers output the same sound in mono, so the sound you hear is the same regardless of where you are within the listening room.

# Recording

This section explains how to record the input source and how to record audio and video from separate sources.

## Notes:

- The surround sound and DSP listening modes cannot be recorded.
- Copy-protected DVDs cannot be recorded.
- Sources connected to the multichannel DVD input cannot be recorded.
- Various restrictions apply to digital recording. Refer to the manuals supplied with your digital recording equipment for more details.
- Digital input signals are output by only the digital outputs, and analog input signals are output by only the analog outputs. There is no internal conversion from digital to analog or vice versa.
- DTS signals will be recorded as noise, so don't attempt analog recording of DTS CDs or LDs.
- While the Pure Audio listening mode is selected, the VIDEO 1 and 2 OUT V and S jacks don't output video signals, so select another mode when recording.

## Recording the Input Source

Audio sources can be recorded to a recorder (e.g., cassette deck, CDR, MD) connected to the TAPE OUT or DIGITAL OPTICAL OUT jacks. Video sources can be recorded to a video recorder (e.g., VCR, DVD recorder) connected to the VIDEO 1 OUT or VIDEO 2 OUT jacks. See pages 24 to 38 for hookup information.

**1**

Remote controller

**Use the input selector buttons to select the source that you want to record.**

See “Which Connections Should I Use?” on page 25 to see which signals can be output and recorded.

You can watch the source while recording. The AV receiver's VOLUME control has no effect on recording.

---

**2**

**On your recorder, start recording.**

---

**3**

**On the source component, start playback.**

## Recording Audio and Video from Separate Sources

You can overdub audio onto your video recordings by simultaneously recording audio and video from two separate sources. This is possible because only the audio source is switched when an audio-only input source, such as TAPE, TUNER, or CD, is selected, the video source remains the same.

In the following example, audio from the CD player connected to the CD IN and video from the camcorder connected to the VIDEO 4 INPUT VIDEO jack are recorded by the VCR connected to the VIDEO 1 OUT jacks.

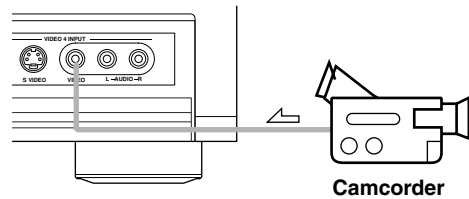

↙ : video signal  
↘ : audio signal

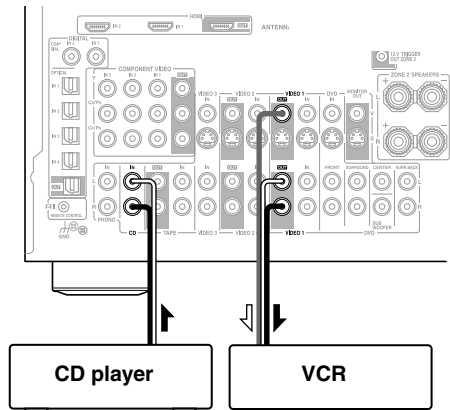

- 1** Prepare the camcorder and CD player for playback.
- 2** Prepare the VCR for recording.
- 3** Press the [VIDEO 4] input selector button.
- 4** Press the [CD] input selector button.  
This selects the CD player as the audio source but leaves the camcorder as the video source.
- 5** Start recording on the VCR, then start playback on the camcorder and CD player.  
Video from the camcorder and audio from the CD player are recorded by the VCR.

## Note:

- If you select another input source during recording, that input source will be recorded.



# Onscreen Setup Menus

## About the Onscreen Setup Menus

The onscreen setup menus are displayed on the connected TV (not via the HDMI OUT) and provide a convenient way to change the AV receiver's settings, which are arranged into two groups: **First Time Setup** and **Advanced Setup**.

To get your system up and running, you must complete the First Time Setup settings. The Advanced Setup settings are more detailed and allow you to tailor the AV receiver to suit your requirements.

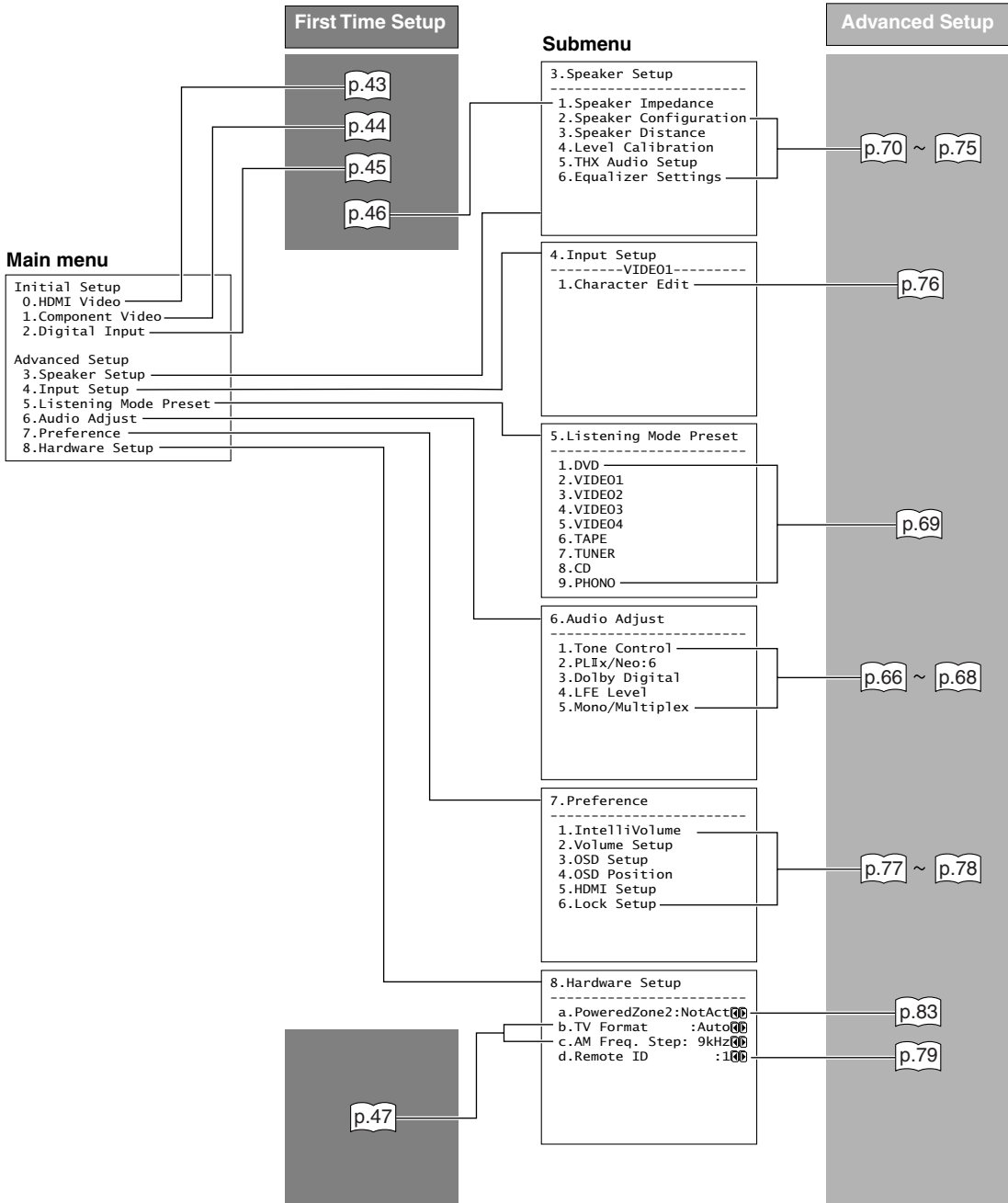

# Adjusting the Listening Modes

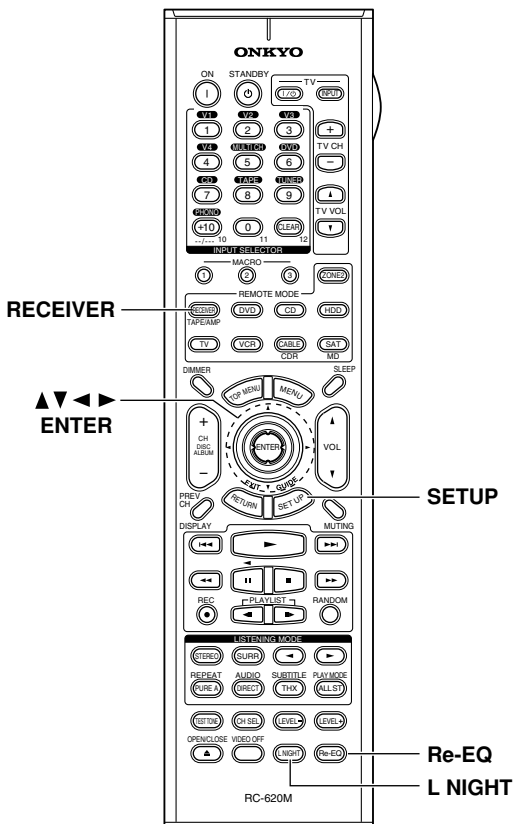

## Using the Re-EQ Function

With the Re-EQ function, you can correct a soundtrack whose high-frequency content is too harsh, making it more suitable for home theater viewing.

This function can be used with the following listening modes: Dolby Digital, Dolby Digital EX, Dolby Pro Logic II Movie, Dolby Pro Logic IIx Movie, DTS, DTS-ES, DTS Neo:6 Cinema, DTS 96/24, THX Cinema, THX Surround EX, THX Select2 Cinema, and Multi-channel.

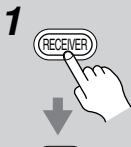
- 

Press the [RECEIVER] REMOTE MODE button, followed by the [Re-EQ] button. Press the [Re-EQ] button again to turn off the Re-EQ function.

## Audio Adjust Menu

The Audio Adjust menu has various settings for adjusting the sound and listening modes.

- 

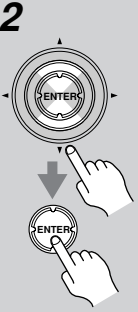
Press the [RECEIVER] REMOTE MODE button, followed by the [SETUP] button. The main menu appears onscreen.
- 

Use the Up and Down [▲]/[▼] buttons to select "6. Audio Adjust," and then press [ENTER]. The Audio Adjust menu appears.

6. Audio Adjust

---

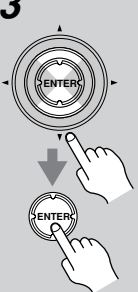
  - 1. Tone Control
  - 2. PLIIx/Neo:6
  - 3. Dolby Digital
  - 4. LFE Level
  - 5. Mono/Multiplex
- 

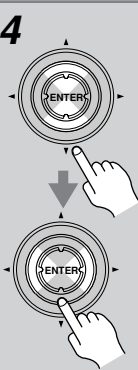
Use the Up and Down [▲]/[▼] buttons to select a setting, and then press [ENTER]. The menu for the selected setting appears.
- 

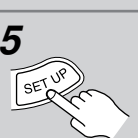
Use the Up and Down [▲]/[▼] buttons to select an option, and use the Left and Right [◀]/[▶] buttons to change it. The Audio Adjust settings are explained on the next page.
- 

When you've finished, press the [SETUP] button. Setup closes.

### Tone Control Settings

You can adjust the bass and treble for the front speakers. The tone control circuits are bypassed in the Direct and Pure Audio listening modes.

#### ■ Bass

You can boost or cut low-frequency sounds output by the front speakers from  $-10$  dB to  $+10$  dB in 1 dB steps.

#### ■ Treble

You can boost or cut high-frequency sounds output by the front speakers from  $-10$  dB to  $+10$  dB in 1 dB steps.

### Setting the Bass and Treble on the AV Receiver:

#### Notes:

- The AV receiver's TONE buttons cannot be used in the Direct and Pure Audio listening modes.
- The tone control settings do not apply to the THX listening modes.

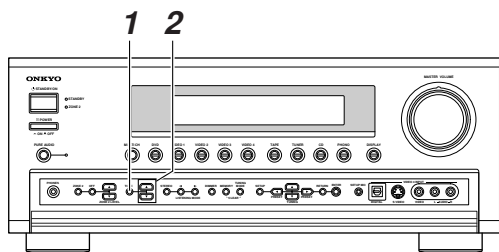

1

TONE



Press the AV receiver's [TONE] button repeatedly to select either Bass or Treble.

2



Use the TONE [▲]/[▼] buttons to adjust.

### PL IIx and Neo:6 Settings

#### PL IIx Music (2 ch only)

These settings only apply to 2-channel (stereo) sources.

#### ■ Panorama

With this setting, you can broaden the width of the front stereo image when using the Pro Logic II Music or Pro Logic IIx Music listening mode.

**On:** Panorama function on.

**Off:** Panorama function off (default).

#### ■ Dimension

With this setting, you can move the sound field forward or backward when using the Pro Logic II Music or Pro Logic IIx Music listening mode. The default value is 3. Higher settings move the sound field forward. Lower settings move it backward. It can be adjusted from 0 to 6. If the stereo image feels too wide, or there's too much surround sound, move the sound field forward to improve the balance. Conversely, if the stereo image feels like it's in mono, or there's not enough surround sound, move it backward.

#### ■ Center Width

With this setting, you can adjust the width of the sound from the center speaker when using the Pro Logic II Music or Pro Logic IIx Music listening mode. Normally if you're using a center speaker, the center channel sound is output by only the center speaker. (If you're not using a center speaker, the center channel sound will be distributed to the front left and right speakers to create a phantom center). This setting adjusts the front left, right, and center mix, allowing you to adjust the weight of the center channel sound. It can be adjusted from 0 to 7 (default value is 3).

#### Neo:6 Music

#### ■ Center Image

The DTS Neo:6 Music listening mode creates 6-channel surround sound from 2-channel (stereo) sources. With this setting, you can specify by how much the front left and right channel output is attenuated in order to create the center channel. It can be adjusted from 0 to 5 (default value is 3). This setting is unavailable if no surround speakers are connected.

When set to 0, the front left and right channel output is attenuated by half ( $-6$  dB), giving the impression that the sound is located centrally. This setting works well when the listening position is considerably off center. When set to 5, the front left and right channels are not attenuated, maintaining the original stereo balance.

### Dolby Digital Settings

---

#### ■ Dolby EX

This setting determines how Dolby Digital EX signals are handled. This setting is unavailable if no surround back speakers are connected or the ZONE 2 SPEAKERS terminals are being used (page 82).

**Auto:** Dolby Digital EX can be selected from among the Dolby listening modes, and THX Surround EX can be selected from among the THX listening modes.

**Manual:** You can select listening modes in accordance with the table on page 61.

#### ■ Late Night

With the Late Night function, you can reduce the dynamic range of Dolby Digital material so that you can still hear quiet parts even when listening at low volume levels—ideal for watching movies late at night when you don't want to disturb anyone.

**Off:** Late Night function off.

**Low:** Small reduction in dynamic range.

**High:** Big reduction in dynamic range.

#### Setting Late Night with the Remote Controller:

The remote controller can be used to set the Late Night function only when the input source is Dolby Digital.



Press the [RECEIVER] REMOTE MODE button, and then press the [L NIGHT] button repeatedly to select: Off, Low, or High.

#### Notes:

- The effect of the Late Night function depends on the Dolby Digital material that you are playing, and with some material there will be little or no effect.
- The Late Night function is set to Off when the AV receiver is set to Standby.

### LFE Level Setting

---

With this setting, you can set the level of the LFE (Low Frequency Effects) channel for Dolby Digital, DTS, MCH PCM (HDMI IN), and MCH Ana (multichannel DVD input). The level can be set to  $-\infty$ ,  $-20$  dB,  $-10$  dB, or  $0$  dB (default).

If you find that the low-frequency effects are too loud when using one of these sources, set the level to  $-20$  dB or  $-\infty$  dB.

### Mono/Multiplex Settings

---

#### Mono

##### ■ Input Ch

This setting determines which channel is output when the Mono listening mode is used with a stereo source.

**Auto L+R:** Both the left and right channels are output (default).

**Left:** Only the left channel is output.

**Right:** Only the right channel is output.

##### ■ Output Sp

This setting determines which speakers output mono audio when the Mono listening mode is selected.

**Front:** Mono audio is output from the front left and right speakers.

**Center:** Mono audio is output from the center speaker (default).

#### Multiplex

##### ■ Multiplex

This setting determines which channel of a stereo multiplex source is output. Use it to select audio channels or languages with multiplex sources, multilingual TV broadcasts, and so on.

**Main:** The main channel is output (default).

**Sub:** The sub channel is output.

**Main/Sub:** Both the main and sub channels are output.

## Default Listening Modes

You can specify a default listening mode for each signal format supported by each input selector. The AV receiver will then automatically select that listening mode based on the format of the input signal. You can select other listening modes while listening to a source, but the default listening mode specified here will be used next time you turn on the AV receiver.

**1**  **Press the [RECEIVER] REMOTE MODE button, followed by the [SETUP] button.**  
The main menu appears onscreen.

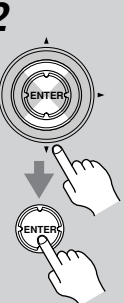
**2**  **Use the Up and Down [▲]/[▼] buttons to select “5. Listening Mode Preset,” and then press [ENTER].**  
The Listening Mode Preset menu appears.

```

5.Listening Mode Preset
-----
1.DVD
2.VIDEO1
3.VIDEO2
4.VIDEO3
5.VIDEO4
6.TAPE
7.TUNER
8.CD
9.PHONO
    
```

**3**  **Use the Up and Down [▲]/[▼] buttons to select an input selector, and then press [ENTER].**  
The options for that input selector appear.

```

5-1.ListeningMode Preset
-----VIDE01-----
  (A)
a.Ana/PCM           :Last Valid  (00)
b.Dolby D           :Last Valid  (00)
c.DTS               :Last Valid  (00)
  (V)
    
```

For the TUNER input selector, the only signal format is “Ana/PCM.”

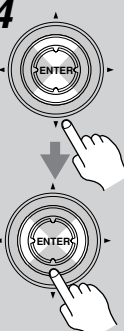
**4**  **Use the Up and Down [▲]/[▼] buttons to select a signal format, and then use the Left and Right [◀]/[▶] buttons to select a listening mode.**  
Only listening modes compatible with each signal format can be selected.  
The signal formats are explained below.

**5**  **When you’ve finished, press the [SETUP] button.**  
Setup closes.

**Note:**  
This procedure can also be performed on the AV receiver by using its [SETUP] button, arrow buttons, and [ENTER] button.

**Ana/PCM:** Specifies the default listening mode for analog sources and PCM digital audio sources.

**Dolby D:** Specifies the default listening mode for Dolby Digital sources.

**DTS:** Specifies the default listening mode for DTS sources.

**D.F. 2ch:** Specifies the default listening mode for 2-channel (2/0) stereo sources in a digital format, such as Dolby Digital and DTS.

**D.F. Mono:** Specifies the default listening mode for mono sources in a digital format, such as Dolby Digital and DTS.

**176.4/192 kHz:** Specifies the default listening mode for high resolution 176.4 kHz and 192 kHz digital audio sources such as DVD-Audio.

**MCH PCM:** Specifies the default listening mode for multichannel PCM sources input via a HDMI IN, such as DVD-Audio.

**MCH Ana:** Specifies the default listening mode for the analog multichannel DVD input. This option is only available for the “1. DVD” input selector.

# Advanced Setup

## Speaker Setup

This section explains how to check the speaker settings and how to set them manually, which is useful if you change a speaker after performing the automatic speaker setup.

Some speaker settings are set automatically by the Automatic Speaker Setup function (see page 40).

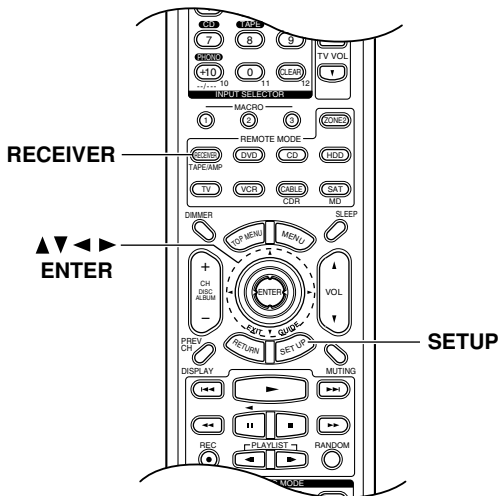

## Speaker Configuration

These settings are set automatically by the Automatic Speaker Setup function (see page 40).

With these settings, you can specify which speakers are connected and a crossover frequency for each speaker.

The following crossover frequencies can be specified: Full Band, 40 Hz, 60 Hz, 70 Hz, 80 Hz (THX), 90 Hz, 100 Hz, 120 Hz, 150 Hz, 200 Hz.

Specify Full Band for speakers that can output low-frequency bass sounds adequately, for example, speakers with a good sized woofer. For smaller speakers, specify a crossover frequency. Sounds below the crossover frequency will be output by the subwoofer instead of the speaker. Refer to your speakers' manuals to determine the optimum crossover frequencies.

If you're using THX-certified speakers, specify 80 Hz (THX) for all speakers.

**1** Press the [RECEIVER] REMOTE MODE button, followed by the [SETUP] button.  
The main menu appears onscreen.

**2** Use the Up and Down [▲]/[▼] buttons to select "3. Speaker Setup," and then press [ENTER].  
The Speaker Setup menu appears.

**3** Use the Up and Down [▲]/[▼] buttons to select "Speaker Configuration," and then press [ENTER].  
The Speaker Config menu appears.

3-2. Speaker Config

-----

a. Subwoofer :Yes**00**

b. Front : 80Hz(THX)**00**

c. Center : 80Hz(THX)**00**

d. Surround : 80Hz(THX)**00**

e. SurrBack : 80Hz(THX)**00**

f. SurrBack Ch : 2ch**00**

g. LPF of LFE : 80Hz(THX)**00**

h. Subwoofer Mode :-----

**4** Use the Up and Down [▲]/[▼] buttons to select "a. Subwoofer," and then use the Left and Right [◀]/[▶] buttons to select:  
Yes: Select if a subwoofer is connected.  
No: Select if no subwoofer is connected.

**5** Use the Up and Down [▲]/[▼] buttons to select "b. Front," and then use the Left and Right [◀]/[▶] buttons to select a crossover frequency.  
**Note:**  
• If the Subwoofer setting in step 4 is set to No, this is fixed at Full Band.

**6** Use the Up and Down [▲]/[▼] buttons to select "c. Center," and then use the Left and Right [◀]/[▶] buttons to select a crossover frequency.  
If no center speaker is connected, select None.  
**Note:**  
• If the Front setting in step 5 is set to anything other than Full Band, Full Band cannot be selected here.

7



Use the Up and Down [▲]/[▼] buttons to select “d. Surround,” and then use the Left and Right [◀]/[▶] buttons to select a crossover frequency.

If no surround left and right speakers are connected, select None.

**Note:**

- If the Front setting in step 5 is set to anything other than Full Band, Full Band cannot be selected here.

8



Use the Up and Down [▲]/[▼] buttons to select “e. SurrBack,” and then use the Left and Right [◀]/[▶] buttons to select a crossover frequency.

If no surround back speakers are connected, select None.

**Notes:**

- If the Surround setting in step 7 is set to None, this setting cannot be selected.
- If the Surround setting in step 7 is set to anything other than Full Band, Full Band cannot be selected here.

9



Use the Up and Down [▲]/[▼] buttons to select “f. SurrBack Ch,” and then use the Left and Right [◀]/[▶] buttons to select:

- 1ch:** Select if one surround back speaker is connected.
- 2ch:** Select if two (left and right) surround back speakers are connected.

Continue with step 10 in the next column.

**Low-Pass Filter for the LFE Channel**

This setting is **not** set automatically by the Automatic Speaker Setup function (see page 40).

With this setting, you can specify the cutoff frequency of the LFE channel’s low-pass filter (LPF), which can be used to filter out unwanted hum. The LPF only applies to sources that use the LFE channel.

\*If you are using THX-certified speakers, select 80 Hz (THX).

10



Use the Up and Down [▲]/[▼] buttons to select “g.LPF of LFE,” and then use the Left and Right [◀]/[▶] buttons to select a low-pass filter frequency.

The following low-pass filter frequencies can be selected: 80 Hz (THX) (default), 90 Hz, 100 Hz, or 120 Hz. Continue with step 11 below.

**Subwoofer Mode**

This setting is **not** set automatically by the Automatic Speaker Setup function (see page 40).

With this setting, you can boost bass output by feeding front left and right channel bass sounds to the subwoofer. This setting can only be made if the Subwoofer setting in step 4 is set to Yes, and the Front setting in step 5 is set to Full Band.

\*If you are using THX-certified speakers, select LFE only (THX).

11



Use the Up and Down [▲]/[▼] buttons to select “h. Subwoofer Mode,” and then use the Left and Right [◀]/[▶] buttons to select:

- LFE only (THX):** The subwoofer only outputs the LFE channel.
- Double Bass:** In addition to LFE channel sounds, the subwoofer outputs front left and right channel bass sounds.

12



Press the [SETUP] button. Setup closes.

**Note:**

- These procedures can also be performed on the AV receiver by using its [SETUP] button, arrow buttons, and [ENTER] button.

## Speaker Distance

These settings are set automatically by the Automatic Speaker Setup function (see page 40).

With these settings, you can specify the distance from each speaker to the listening position.

**1**  **Press the [RECEIVER] REMOTE MODE button, followed by the [SETUP] button.**  
The main menu appears onscreen.

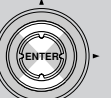
**2**  **Use the Up and Down [▲]/[▼] buttons to select “3. Speaker Setup,” and then press [ENTER].**  
The Speaker Setup menu appears.

**3**  **Use the Up and Down [▲]/[▼] buttons to select “Speaker Distance,” and then press [ENTER].**  
The Speaker Distance menu appears.

3-3. Speaker Distance

|              |       |    |
|--------------|-------|----|
| a.Unit       | :feet | 00 |
| b.Left       | :12ft | 00 |
| c.Center     | :12ft | 00 |
| d.Right      | :12ft | 00 |
| e.Surround R | : 7ft | 00 |
| f.SurrBack R | : 7ft | 00 |
| g.SurrBack L | : 7ft | 00 |
| h.Surround L | : 7ft | 00 |
| i.Subwoofer  | :12ft | 00 |

**Note:**  
Speakers that you set to No or None on the Speaker Config menu (page 70) cannot be selected.

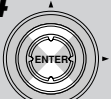
**4**  **Use the Up and Down [▲]/[▼] buttons to select “a. Unit,” and then use the Left and Right [◀]/[▶] buttons to select:**  
**feet:** Select if you want to enter distances in feet. Can be set from 1 to 30 feet in 1-foot steps.  
**meters:** Select if you want to enter distances in meters. Can be set from 0.3 to 9 meters in 0.3-meter steps.

**5**  **Use the Up and Down [▲]/[▼] buttons to select each speaker and then use the Left and Right [◀]/[▶] buttons to specify the distance.**  
Specify the distance from the speaker to your listening position.

**6** **Repeat step 5 for all speakers.**

**7**  **Press the [SETUP] button.**  
Setup closes.

**Note:**

- This procedure can also be performed on the AV receiver by using its [SETUP] button, arrow buttons, and [ENTER] button.



## Speaker Level Calibration

These settings are set automatically by the Automatic Speaker Setup function (see page 40).

With these settings, you can adjust the level of each speaker while listening to the test tone so that the volume of each speaker is the same at the listening position.

### Notes:

- The speakers cannot be calibrated while the output of the AV receiver is muted or a pair of headphones is connected.
- Because the AV receiver supports THX, the test tone is output at the standard level of 0 dB (absolute volume setting 82). If you normally listen at volume settings below this, be careful because the test tone will be much louder.

**1**  **Press the [RECEIVER] REMOTE MODE button, followed by the [SETUP] button.**  
The main menu appears onscreen.

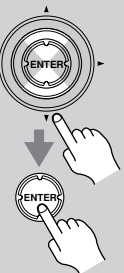
**2**  **Use the Up and Down [▲]/[▼] buttons to select “3. Speaker Setup,” and then press [ENTER].**  
The Speaker Setup menu appears.

**3**  **Use the Up and Down [▲]/[▼] buttons to select “Level Calibration,” and then press [ENTER].**  
The Level Calibration menu appears and the pink noise test tone is output by the front left speaker.

3-4. Level Calibration

|               |       |
|---------------|-------|
| a. Left       | : 0dB |
| b. Center     | : 0dB |
| c. Right      | : 0dB |
| d. Surround R | : 0dB |
| e. SurrBack R | : 0dB |
| f. SurrBack L | : 0dB |
| g. Surround L | : 0dB |
| h. Subwoofer  | : 0dB |

**Note:**  
Speakers that you set to No or None on the Speaker Config menu (page 70) cannot be adjusted.

**4**  **Use the Up and Down [▲]/[▼] buttons to select each speaker, and use the Left and Right [◀]/[▶] buttons to set the volume.**  
The level can be adjusted from -12 to +12 dB in 1 dB steps (-15 to +12 dB for the subwoofer).

**5** **Repeat step 4 so that the volume of the test tone from each speaker is the same.**  
If you're using a handheld sound level meter, adjust the level of each speaker so it reads 75 dB SPL at the listening position, measured with C-weighting and slow reading.

**6**  **Press the [SETUP] button.**  
Setup closes.

### Note:



- The speaker levels can also be changed by using the dedicated buttons on the remote controller. Press the [TEST TONE] button to output the test tone. Use the [CH SEL] button to select each speaker, and use the [LEVEL-] and [LEVEL+] buttons to adjust the level.



## THX Audio Setup

This setting is **not** set automatically by the Automatic Speaker Setup function (see page 40).

This setting is only available if the SurrBack Ch setting in the Speaker Configuration is set to 2ch.

With this setting, you can specify the distance between your surround back speakers. To get the best from THX's ASA (Advanced Speaker Array) technology, these speakers should be placed as close together as possible.

|   |  |
|---|--|
| <p><b>1</b></p>    | <p><b>Press the [RECEIVER] REMOTE MODE button, followed by the [SETUP] button.</b><br/>The main menu appears onscreen.</p>   |
| <p><b>2</b></p>   | <p><b>Use the Up and Down [▲]/[▼] buttons to select “3. Speaker Setup,” and then press [ENTER].</b><br/>The Speaker Setup menu appears.</p>  |
| <p><b>3</b></p>  | <p><b>Use the Up and Down [▲]/[▼] buttons to select “THX Audio Setup,” and then press [ENTER].</b><br/>The THX Audio Setup menu appears.</p> <div data-bbox="319 1257 614 1495" style="border: 1px solid black; padding: 5px; margin-top: 10px;"> <pre> 3-5.THX Audio Setup ----- a.SurrBack Sp Spacing    : 0-1ft00                     </pre> </div> |

|   |  |
|---|--|
| <p><b>4</b></p>  | <p><b>Use the Left and Right [◀]/[▶] buttons to specify the surround back speaker spacing:</b><br/> <b>0–1 ft (0–0.3 m) (Default):</b> Select this if the speakers are between 0 and 1 foot (0–30 cm) apart.<br/> <b>1–4 ft (0.3–1.2 m):</b> Select this if the speakers are between 1 and 4 feet (0.3–1.2 m) apart.<br/> <b>&gt;4 ft (&gt;1.2 m):</b> Select this if the speakers are more than 4 feet (1.2 m) apart.</p> |
| <p><b>5</b></p>  | <p><b>Press the [SETUP] button.</b><br/>The setup menu closes.</p>   |





**Note:**





- This procedure can also be performed on the AV receiver by using its [SETUP] button, arrow buttons, and [ENTER] button.

## Equalizer Settings

These settings are set automatically by the Automatic Speaker Setup function (see page 40).

With these settings, you can adjust the tone of each speaker. The volume of each speaker can be set on page 73.

|   |   |
|---|---|
| <p><b>1</b></p>    | <p><b>Press the [RECEIVER] REMOTE MODE button, followed by the [SETUP] button.</b><br/>The main menu appears onscreen.</p>  |
| <p><b>2</b></p>    | <p><b>Use the Up and Down [▲]/[▼] buttons to select “3. Speaker Setup,” and then press [ENTER].</b><br/>The Speaker Setup menu appears.</p>   |
| <p><b>3</b></p>  | <p><b>Use the Up and Down [▲]/[▼] buttons to select “Equalizer Settings,” and then press [ENTER].</b><br/>The Equalizer Settings menu appears.</p>  |
| <p><b>4</b></p>  | <p><b>Use the Left and Right [◀]/[▶] buttons to set the “a. Use Settings” option to:</b></p> <p><b>Off:</b> Equalizer off, flat response.</p> <p><b>Auto:</b> The equalizer for each speaker is set automatically by the Automatic Speaker Setup function.</p> <p><b>Manual:</b> The equalizer for each speaker can be set manually.</p> <p>If you selected Manual, continue with the next step. If you selected Off or Auto, go to step 8.</p> |

| <p><b>5</b></p>    | <p><b>Use the Down [▼] button to select “b. Channel,” and then use the Left and Right [◀]/[▶] buttons to select a speaker.</b></p> <table border="1" data-bbox="898 318 1200 550"> <thead> <tr> <th colspan="2">3-6. Equalizer Settings</th> </tr> </thead> <tbody> <tr> <td>a. Use Settings:</td> <td>Manual</td> </tr> <tr> <td>b. Channel :</td> <td>Left</td> </tr> <tr> <td>c. 80Hz :</td> <td>0dB</td> </tr> <tr> <td>d. 250Hz :</td> <td>0dB</td> </tr> <tr> <td>e. 800Hz :</td> <td>0dB</td> </tr> <tr> <td>f. 2.5kHz :</td> <td>0dB</td> </tr> <tr> <td>g. 8kHz :</td> <td>0dB</td> </tr> </tbody> </table> | 3-6. Equalizer Settings |  | a. Use Settings: | Manual | b. Channel : | Left | c. 80Hz : | 0dB | d. 250Hz : | 0dB | e. 800Hz : | 0dB | f. 2.5kHz : | 0dB | g. 8kHz : | 0dB |
|---|--|-------------------------|--|------------------|--------|--------------|------|-----------|-----|------------|-----|------------|-----|-------------|-----|-----------|-----|
| 3-6. Equalizer Settings   |  |                         |  |                  |        |              |      |           |     |            |     |            |     |             |     |           |     |
| a. Use Settings:  | Manual   |                         |  |                  |        |              |      |           |     |            |     |            |     |             |     |           |     |
| b. Channel :  | Left   |                         |  |                  |        |              |      |           |     |            |     |            |     |             |     |           |     |
| c. 80Hz :   | 0dB  |                         |  |                  |        |              |      |           |     |            |     |            |     |             |     |           |     |
| d. 250Hz :  | 0dB  |                         |  |                  |        |              |      |           |     |            |     |            |     |             |     |           |     |
| e. 800Hz :  | 0dB  |                         |  |                  |        |              |      |           |     |            |     |            |     |             |     |           |     |
| f. 2.5kHz :   | 0dB  |                         |  |                  |        |              |      |           |     |            |     |            |     |             |     |           |     |
| g. 8kHz :   | 0dB  |                         |  |                  |        |              |      |           |     |            |     |            |     |             |     |           |     |
| <p><b>6</b></p>    | <p><b>Use the Up and Down [▲]/[▼] buttons to select a frequency, and then use the Left and Right [◀]/[▶] buttons to cut or boost that frequency.</b></p> <p>Each band can be cut or boosted from -6 dB to +6 dB in 1 dB steps.</p> <p><b>Tip:</b> Low frequencies (e.g., 80Hz) affect bass sounds; high frequencies (e.g., 8kHz) affect treble sounds.</p>   |                         |  |                  |        |              |      |           |     |            |     |            |     |             |     |           |     |
| <p><b>7</b></p>   | <p><b>Use the Up [▲] button to select “b. Channel,” and then use the Left and Right [◀]/[▶] buttons to select another speaker.</b><br/>Repeat steps 6 and 7 for each speaker.</p>  |                         |  |                  |        |              |      |           |     |            |     |            |     |             |     |           |     |
| <p><b>8</b></p>  | <p><b>Press the [SETUP] button.</b><br/>Setup closes.</p>  |                         |  |                  |        |              |      |           |     |            |     |            |     |             |     |           |     |

### Notes:





- This procedure can also be performed on the AV receiver by using its [SETUP] button, arrow buttons, and [ENTER] button.
- The Equalizer Settings have no effect on 176.4/192 kHz signals.

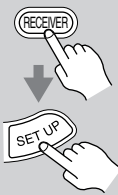

## Input Setup

This section explains items on the “Input Setup” menu.

### Character Edit

With this setting, you can enter a custom name for each input source and AM/FM radio preset. When the input source or radio preset is selected, its name will appear on the display.

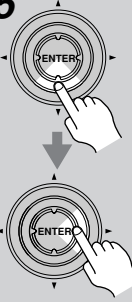
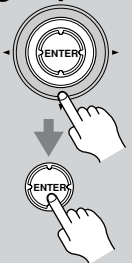
|   |   |
|---|---|
| <p><b>1</b></p>    | <p><b>Press the [RECEIVER] REMOTE MODE button, followed by the [SETUP] button.</b></p> <p>To name an AM or FM radio preset, select that preset first.</p>   |
| <p><b>2</b></p>    | <p><b>Use the Up and Down [▲]/[▼] buttons to select “4. Input Setup,” and then press [ENTER].</b></p> <p>The Input Setup menu appears.</p>  |
| <p><b>3</b></p>   | <p><b>Use the Up and Down [▲]/[▼] buttons to select “Character Edit,” and then press [ENTER].</b></p> <p>The Character Edit menu appears.</p> <div data-bbox="322 1052 617 1294" style="border: 1px solid black; padding: 5px;"> <pre> 4-1.Character Edit -----VIDE01----- a.Character Display      :Yes[0] b.Character : Press[0]to Edit [0]to Clear                     </pre> </div> |
| <p><b>4</b></p>  | <p><b>Use the Up and Down [▲]/[▼] buttons to select “Character Display,” and use the Left and Right [◀]/[▶] buttons to select:</b></p> <p><b>No (Default):</b> The default name is displayed.</p> <p><b>Yes:</b> The custom name is displayed.</p> <p>For radio presets, the frequency is displayed when No is selected.</p>  |

|   |   |
|---|---|
| <p><b>5</b></p>    | <p><b>Press the Down [▼] button to select “Character,” and then press the Right [▶] button to open the character input screen.</b></p> <div data-bbox="912 309 1207 550" style="border: 1px solid black; padding: 5px;"> <pre> 4-1.Character Edit -----VIDE01----- b.Character  : -----+  : ABCDEFHIJKLM   : NOPQRSTUVWXYZ   : abcdefghi jklm   : nopqrstuvwxyz   : 0123456789-.'   : O+*/=,.;!/?_    : [Exit]   : -----+                     </pre> </div>   |
| <p><b>6</b></p>    | <p><b>Use the arrow [▲]/[▼]/[◀]/[▶] buttons to select a character, and then press [ENTER]. Repeat this step to enter up to 10 characters.</b></p> <p><b>If you enter a character by mistake:</b> Press the [RETURN] button to move the cursor back one place.</p> <p><b>To correct a character:</b></p> <ol style="list-style-type: none"> <li>1. Press the [ENTER] or [RETURN] button repeatedly to select the character to be corrected.</li> <li>2. Use the Left and Right [◀]/[▶] buttons to select the new character, and then press [ENTER].</li> </ol> <p>If the name contains less than 10 characters, select “Exit,” and then press [ENTER].</p> |
| <p><b>7</b></p>  | <p><b>Press the [SETUP] button.</b></p> <p>Setup closes.</p>  |

**To delete all the characters in a name:**  
In step 5, press the Left [◀] button instead of the Right [▶] button.

**Notes:**

- When the multichannel input is selected, the same name as for DVD is displayed.
- XM Radio presets cannot be named.
- This procedure can also be performed on the AV receiver by using its [SETUP] button, arrow buttons, and [ENTER] button.

## Preferences

This section explains items on the “Preference” menu.

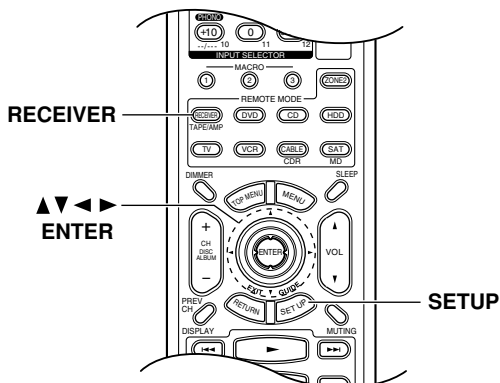

4



Use the Up and Down [**▲**]/[**▼**] buttons to select an option, and use the Left and Right [**◀**]/[**▶**] buttons to change it.

The preferences are explained in the next column.

5



When you've finished, press the [SETUP] button.

Setup closes.

### Note:

- This procedure can also be performed on the AV receiver by using its [SETUP] button, arrow buttons, and [ENTER] button.

1

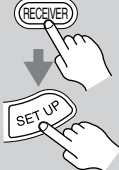

Press the [RECEIVER] REMOTE MODE button, followed by the [SETUP] button.

The main menu appears onscreen.

2

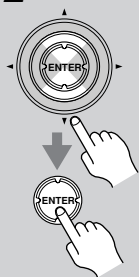

Use the Up and Down [**▲**]/[**▼**] buttons to select “7. Preference,” and then press [ENTER].

The Preference menu appears.

#### 7. Preference

- 1. IntelliVolume
- 2. Volume Setup
- 3. OSD Setup
- 4. OSD Position
- 5. HDMI Setup
- 6. Lock Setup

3

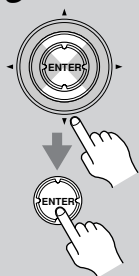

Use the Up and Down [**▲**]/[**▼**] buttons to select a preference, and then press [ENTER].

## IntelliVolume

With this preference, you can set the input level for each input source. This is useful if some of your components are louder or quieter than others. IntelliVolume does not affect Zone 2.

Use the Up and Down [**▲**]/[**▼**] buttons to select an input selector, and use the Left and Right [**◀**]/[**▶**] buttons to set the level.

If a component is too loud compared to your other components, use the Left [**◀**] button to reduce its input level. If it's too quiet, use the Right [**▶**] button to increase its input level. The level can be set from -12 dB to +12 dB.

## Volume Setup

### ■ Volume Display

With this preference, you can choose how the volume level is displayed.

**Absolute:** Display range is MIN, 1 through 99, MAX.

**Relative:** Display range is -∞ dB, -81 dB, -80 dB through +18 dB.

The absolute value 82 is equivalent to the relative value 0 dB.

### ■ Muting Level

This preference determines how much the output is muted when the Muting function is used (see page 58). It can be set to -∞ dB (default) or between -50 dB and -10 dB in 10 dB steps.

### ■ Maximum Vol

With this preference, you can prevent the volume being set too high by specifying a maximum volume level. When the “Volume Display” preference is set to “Absolute,” the range is from 50 to 99. When it's set to “Relative,” the range is -32 dB to +17 dB. To specify no maximum volume, select “Off.”

### ■ Power On Vol

With this preference, you can specify the volume setting to be used when the AV receiver is turned on.

When the Volume Display preference is set to Absolute, the range is 0 to 100. When it's set to Relative, the range is  $-\infty$  dB,  $-81$  dB to  $+18$  dB.

To use the same volume level as when the AV receiver was turned off, select "Last."

The "Power On Vol" cannot be set higher than the "Maximum Vol" setting.

### ■ Headphones Level

With this preference, you can specify the headphone volume relative to the main volume. This is useful if there's a volume difference between your speakers and your headphones. The headphones level can be set from  $-12$  dB to  $+12$  dB.

## OSD Setup

---

These settings determine how the operation details are displayed.

### ■ Immediate Display

This preference determines whether operation details are displayed onscreen when an AV receiver function is adjusted.

**On:** Displayed (default).

**Off:** Not displayed.

Even when On is selected, operation details are not output if the input source is connected to a COMPONENT VIDEO IN or HDMI IN.

For optimum video performance, THX recommends that the Immediate Display preference is set to Off.

### ■ Monitor Type

With this preference, you can specify the aspect ratio of your TV so that the operation details are displayed properly.

**4:3:** Select if your TV is 4:3 (default).

**16:9:** Select if your TV is 16:9.

### ■ Display Position

This preference determines where on the screen operation details are displayed.

**Bottom:** Bottom of the screen (default).

**Top:** Top of the screen.

## OSD Position

---

With this preference, you can specify the position of the onscreen setup menus. This is useful with TVs or projectors where the menus don't appear in the center of the screen, or part of the menu is cut off.

To set the menu position, use the arrow [ $\blacktriangle$ ]/[ $\blacktriangledown$ ]/[ $\blacktriangleleft$ ]/[ $\blacktriangleright$ ] buttons. To set it back to its default position, press [ENTER].

## HDMI Setup

---

### ■ HDMI Audio Out

This preference determines whether audio received at the HDMI IN is output by the HDMI OUT. You may want to turn this preference on if your TV is connected to the HDMI OUT and you want to listen to the audio from a component that's connected to an HDMI IN, through your TV's speakers. Normally, this should be set to Off.

**Off:** HDMI audio is not output (default).

**On:** HDMI audio is output.

With some TVs and input signals, no sound may be output even when this setting is set to On.

## Lock Setup

---

### ■ Lock

With this preference, you can protect your settings by locking the setup menus.

When the setup menus are locked, only settings on the Audio Adjust menu can be changed.

**Locked:** Setup menus locked.

**Unlocked:** Setup menus not locked.

Remote IDs

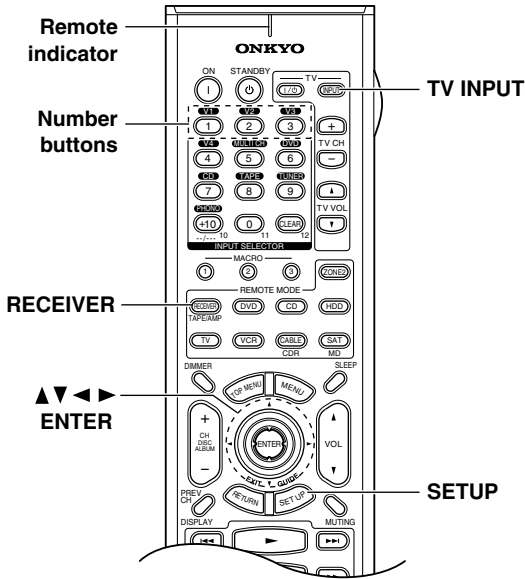

**3** Use the Up and Down [**▲**]/[**▼**] buttons to select “Remote ID,” and use the Left and Right [**◀**]/[**▶**] buttons to select ID 1, 2, or 3.

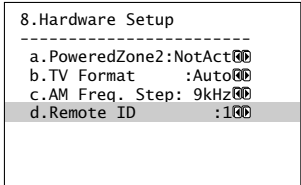

**4** Press the [SETUP] button. Setup closes.

**Note:**

- This procedure can also be performed on the AV receiver by using its [SETUP] button, arrow buttons and [ENTER] button.

**Changing the AV Receiver's Remote ID**

When several Onkyo components are used in the same room, their remote ID codes may overlap. To differentiate the AV receiver from the other components, you can change its remote ID from 1, the default, to 2 or 3.

**Note:**

If you change the AV receiver's remote ID, be sure to set the remote controller to the same ID (see next column).

**1** Press the [RECEIVER] REMOTE MODE button, followed by the [SETUP] button. The main menu appears onscreen.

**2** Use the Up and Down [**▲**]/[**▼**] buttons to select “8. Hardware Setup,” and then press [ENTER]. The Hardware Setup menu appears.

**1** Press and hold down the [RECEIVER] REMOTE MODE button, and then press the TV [INPUT] button. The Remote indicator flashes four times.

**2** Use the number buttons to enter remote control ID 1, 2, or 3. The Remote indicator flashes twice.

### Digital Input Signal Formats

Normally, the AV receiver detects the signal format automatically. However, if you experience either of the following issues when playing PCM or DTS material, you can specify the signal format as either PCM or DTS:

- If the beginnings of tracks from a PCM source are cut off, try the PCM setting.
- If noise is produced when fast forwarding or rewinding a DTS CD, try the DTS setting.

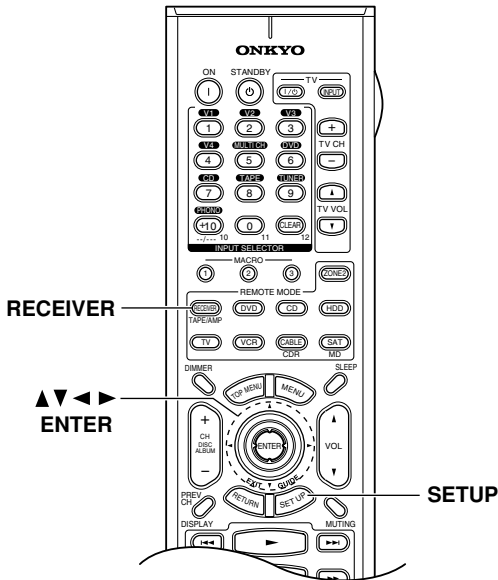

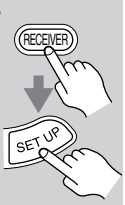
**1**  Press the [RECEIVER] REMOTE MODE button, followed by the [SETUP] button. The main menu appears onscreen.

**2**  Use the Up and Down [▲]/[▼] buttons to select “2. Digital Input,” and then press [ENTER].

**3**  Use the Up and Down [▲]/[▼] buttons to select an input source that’s assigned to a digital input (opt, coax, or HDMI), and then press [ENTER]. The Digital Format menu appears.

| 2-1. Digital Format |       |
|---------------------|-------|
| a. DVD              | :Auto |
| b. VIDEO1           | :Auto |
| c. VIDEO2           | :---  |
| d. VIDEO3           | :Auto |
| e. VIDEO4           | :Auto |
| f. TAPE             | :---  |
| g. CD               | :Auto |
| h. PHONO            | :---  |

**4**  Use the Up and Down [▲]/[▼] buttons to select the input, and use the Left and Right [◀]/[▶] buttons to select: PCM, DTS, or Auto.

**PCM:** The PCM indicator flashes, and only input signals in PCM format will be output.

**DTS:** The DTS indicator flashes, and only input signals in DTS format will be output.

**Auto (default):** The format is detected automatically. If no digital input signal is present, the corresponding analog input is used instead.

**5**  Press the [SETUP] button. Setup closes.

**Note:**



- This procedure can also be performed on the AV receiver by using its [SETUP] button, arrow buttons, and [ENTER] button.

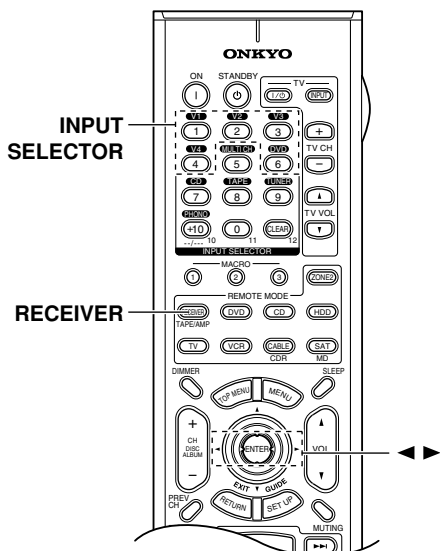

## Correcting Sound and Picture Sync

When using progressive scanning on your DVD player, you may find that the picture and sound are out of sync. With this setting, you can correct this by delaying the audio signals. You can set it from 0 to 250 milliseconds (ms) in 1 millisecond steps.



- |   |   |
|---|---|
| <p><b>1</b></p>  | <p><b>Press the [RECEIVER] REMOTE MODE button.</b></p>  |
| <p><b>2</b></p>  | <p><b>Press and hold, for more than 4 seconds, the input selector button for the input source that you want to correct.</b></p> <p>This can be the [DVD], [VIDEO 1], [VIDEO 2], [VIDEO 3], or [VIDEO 4] input source.</p>                             |
| <p><b>3</b></p>  | <p><b>Use the Left and Right [◀]/[▶] buttons to adjust the delay from 0 to 250 milliseconds in 1 millisecond steps.</b></p> <div style="border: 1px solid black; padding: 5px; width: fit-content; margin: 10px auto;"> <p>A/V Sync : 20ms</p> </div> |

**Note:**

- This setting is not available when the Pure Audio listening mode is used, or the Direct listening mode is used with an analog input signal.

# Zone 2

## Connecting Zone 2

With the Zone 2 function, you can enjoy one input source in the main room and a different input source in another room.

**There are two ways to hook up your Zone 2 speakers:**

- 1) Use an amp (receiver or integrated amp) in Zone 2 and connect your Zone 2 speakers to it.
- 2) Connect your Zone 2 speakers to this AV receiver.

## Using an Amp in Zone 2

With this hookup, you can enjoy 7.1-channel playback in the main room and a different stereo source in Zone 2. The volume for Zone 2 is set on the other amp.

### Hookup

- Use an RCA audio cable to connect the AV receiver's ZONE 2 LINE OUT L/R jacks to an analog audio input on the amp in Zone 2.
- Connect the Zone 2 speakers to the speaker terminals on the amp in Zone 2.

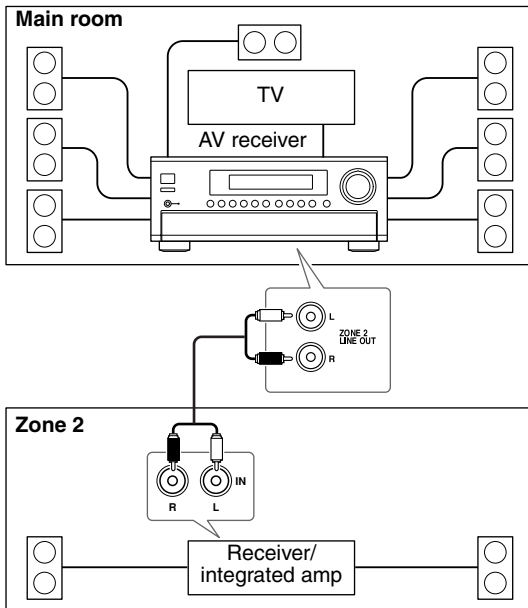

You don't need to make any settings to use this hookup. Proceed to "Using Zone 2" on page 83.

## Using Only Speakers in Zone 2

With this hookup, you can enjoy 5.1-channel playback in the main room and a different stereo source in Zone 2. The volume for Zone 2 is set on this AV receiver.

### Hookup

- Connect your Zone 2 speakers to the AV receiver's ZONE 2 SPEAKERS terminals.

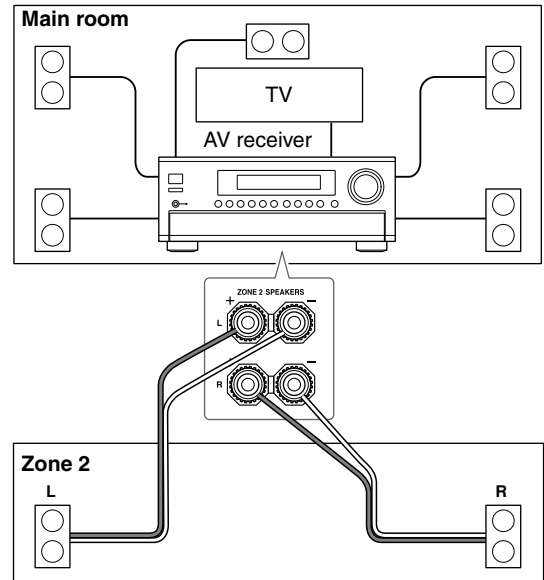



You must set the "Powered Zone 2" setting to "Act" (Activated) in order to use this hookup (see page 83).

## Zone 2 12V Trigger

When Zone 2 is turned on, the ZONE 2 12V TRIGGER OUT goes high (+12 volts, 100 milliamperes max). Connecting this jack to a 12-volt trigger input on a component in Zone 2 will turn that component on or off when Zone 2 is turned on or off on this AV receiver.

### Powered Zone 2 Setting

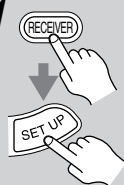
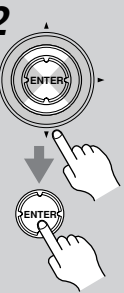
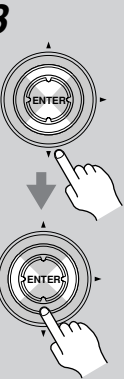
If you've connected your Zone 2 speakers to this AV receiver, as explained in "Using Only Speakers in Zone 2" on page 82, you must set the "Powered Zone 2" setting to "Act" (Activated) as explained here.

|          |  |
|----------|--|
| <b>1</b> |  <p><b>Press the [RECEIVER] REMOTE MODE button, followed by the [SETUP] button.</b><br/>The main menu appears onscreen.</p>   |
| <b>2</b> |  <p><b>Use the Up and Down [▲]/[▼] buttons to select "8. Hardware Setup," and then press [ENTER].</b><br/>The Hardware Setup menu appears.</p>  |
| <b>3</b> |  <div style="border: 1px solid black; padding: 5px; margin: 10px 0;"> <p>8. Hardware Setup</p> <hr/> <p>a. PoweredZone2: NotAct</p> <p>b. TV Format : Auto</p> <p>c. AM Freq. Step: 9kHz</p> <p>d. Remote ID : 1</p> </div> <p><b>Use the Up and Down [▲]/[▼] buttons to select "Powered Zone2," and use the Left and Right [◀]/[▶] buttons to select:</b></p> <p><b>Not Act:</b> ZONE 2 SPEAKERS terminals not activated.<br/><b>Act:</b> ZONE 2 SPEAKERS terminals activated.</p> <p>When Act is selected and Zone 2 is turned on, the speakers connected to the ZONE 2 SPEAKERS terminals will output sound, but the speakers connected to the SURROUND BACK SPEAKERS terminals will not. When Zone 2 is turned off, even if Act is selected, the surround back speakers will work as normal.</p> |
| <b>4</b> |  <p><b>Press the [SETUP] button.</b><br/>Setup closes.</p>  |

**Note:**



- This procedure can also be performed on the AV receiver by using its [SETUP] button, arrow buttons, and [ENTER] button.

### Using Zone 2

This section explains how to turn Zone 2 on and off, how to select an input source for Zone 2, and how to adjust the volume for Zone 2.

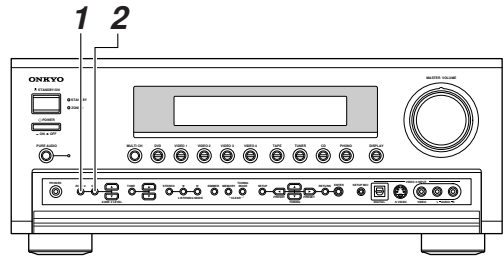
#### Controlling Zone 2 from the AV receiver



|          |   |
|----------|---|
| <b>1</b> |  <p><b>To turn on Zone 2 and select an input source, press the [ZONE 2] button repeatedly.</b></p> <p><b>Alternatively, press the [ZONE 2] button followed by an input selector button within 8 seconds.</b></p> <p>Zone 2 turns on, the ZONE 2 indicator lights up, and the ZONE 2 12V TRIGGER OUT goes high (+12 V).</p> <p>To select AM, FM, or XM (North American model only), press the [TUNER] input selector button repeatedly.</p> <p>To select the same source as that of the main room, press the [ZONE 2] button repeatedly until "Zone 2 Sel: Source" appears.</p> |
| <b>2</b> |  <p><b>To turn off Zone 2, press the ZONE 2 [OFF] button.</b></p>  |

**Controlling Zone 2 with the Remote Controller**

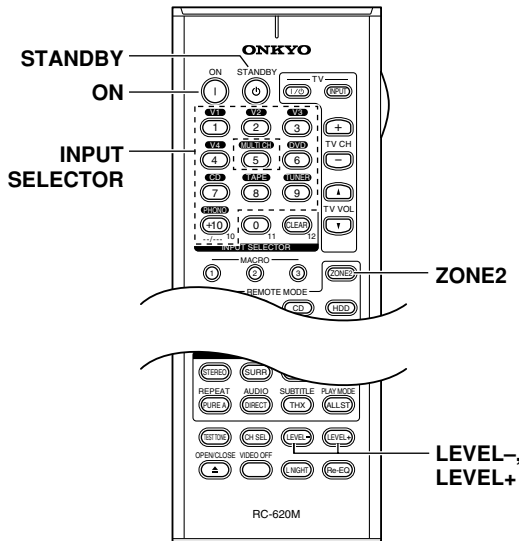

**Note:**

- To control Zone 2, you must press the remote controller's [ZONE 2] REMOTE MODE button first.

**1**



Press the [ZONE 2] REMOTE MODE button, then point the remote controller at the AV receiver and press the [ON] button.



Zone 2 turns on, and the ZONE 2 12V TRIGGER OUT goes high (+12 V).

**2**



To select an input source for Zone 2, press the [ZONE 2] REMOTE MODE button, followed by an INPUT SELECTOR button.

To select AM, FM, or XM, press the [TUNER] INPUT SELECTOR button repeatedly.



**3**



To turn off Zone 2, press the [ZONE 2] REMOTE MODE button, followed by the [STANDBY] button.



**Adjusting the Volume for Zone 2**

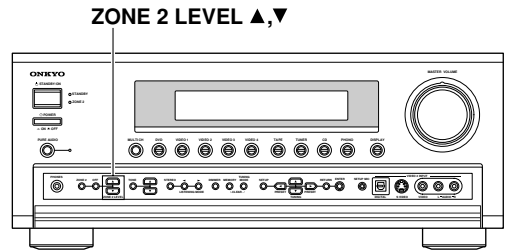

**1**



On the remote controller, press the [ZONE 2] REMOTE MODE button, and then use the [LEVEL-] and [LEVEL+] buttons.



On the AV receiver, use the ZONE 2 LEVEL [▲]/[▼] buttons.

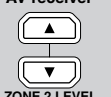

If your Zone 2 speakers are connected to an amp in Zone 2, use its volume control to adjust the volume.

**To Mute Zone 2:**

Press the remote controller's [ZONE 2] button, followed by the [MUTING] button. To unmute Zone 2, press the remote controller's [ZONE 2] button again, followed by the [MUTING] button, or adjust the volume for Zone 2.

**Notes:**

- Only analog input sources are output by the ZONE 2 LINE OUT and ZONE 2 SPEAKERS terminals. Digital input sources are not output. If no sound is heard when an input source is selected, check to see if it's connected to an analog input.
- When the ZONE 2 SPEAKERS terminals are used, listening modes that require surround back speakers, such as Dolby Digital EX, DTS-ES, and THX Select2 Cinema, are unavailable.
- While Zone 2 is on, the **RI** functions do not work.
- You can't select different radio stations for the main room and Zone 2. The same radio station will be used for both.

### Using the Remote Controller in Zone 2 and Multiroom Control Kits

To control the AV receiver with the remote controller while you're in the Zone 2 room, you'll need a commercially available multiroom remote control kit.

- Multiroom kits are made by Niles and Xantech. These kits can also be used when there isn't a clear line of sight to the AV receiver's remote sensor, such as when it's installed inside a cabinet.

### Using a Multiroom Kit with Zone 2

In this setup, the IR receiver in Zone 2 picks up the infrared signals from the remote controller and feeds them through to the AV receiver in the main room via the connecting block.

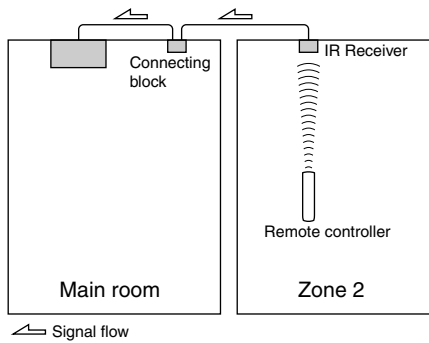

The miniplug cable from the connecting block should be connected to the AV receiver's IR IN jack, as shown below.

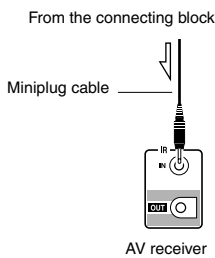

### Using a Multiroom Kit with a Cabinet

In this setup, the IR receiver picks up the infrared signals from the remote controller and feeds them to the AV receiver located in the cabinet via the connecting block.

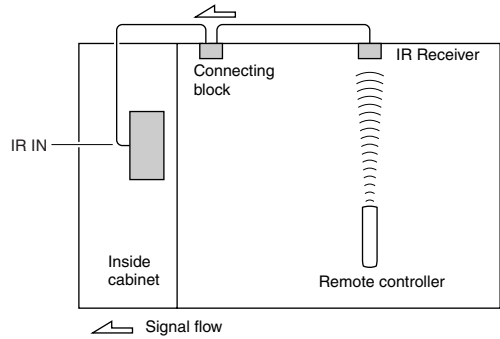

### Using a Multiroom Kit with Other Components

In this setup, an IR emitter is connected to the AV receiver's IR OUT jack and placed in front of the other component's remote control sensor. Infrared signals received at the AV receiver's IR IN jack are fed through to the other component via the IR emitter. Signals picked up by the AV receiver's remote control sensor are not output.

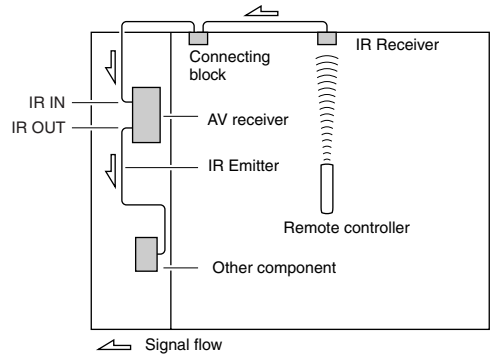

The IR emitter should be connected to the AV receiver's IR OUT jack, as shown below.

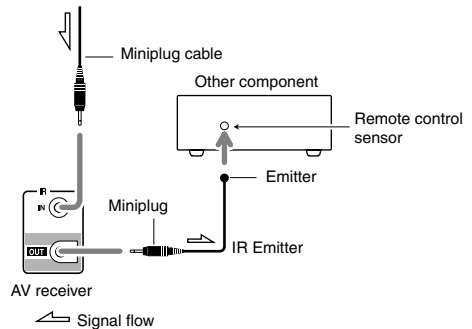

# Controlling Other Components

You can control your other components, including those made by other manufacturers, with the remote controller. This section explains how to:

- Enter the remote control code for a component that you want to control (e.g., DVD, TV, VCR).
- Learn commands directly from another component's remote controller (see page 89).
- Program the MACRO buttons to perform a sequence of up to eight actions (see page 90).

## Entering Remote Control Codes

To control another component, you must first enter the appropriate remote control code to a REMOTE MODE button. You'll need to enter a code for each component that you want to control.

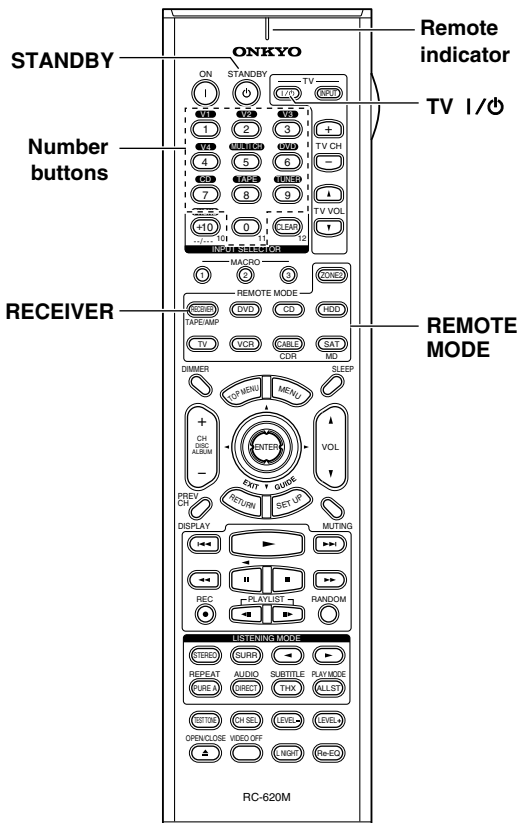

**1**

**Look up the appropriate remote control code in the separate Remote Control Codes list.**

The codes are organized by category.

**2**

REMOTE MODE

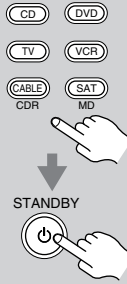

**While holding down the REMOTE MODE button to which you want to enter the code, press the [STANDBY] button.**

The Remote indicator lights up.

**3**

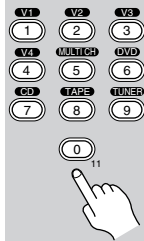

**Within 30 seconds, use the number buttons to enter the 4-digit remote control code.**

The Remote indicator flashes twice.

**4**

**Press the REMOTE MODE button again to select the remote controller mode, point the remote controller at the component, and check the operation.**

If the remote controller doesn't work as expected, and several remote codes are listed, try each one in turn and use the one that works best.

### Notes:

- Remote control codes cannot be entered for the [RECEIVER] and [HDD] REMOTE MODE buttons.
- The remote control codes provided are correct at the time of printing, but are subject to change.

- The HDD remote mode can only be used with the Onkyo Remote Interactive Dock at this time.
- The [DVD] and [CD] REMOTE MODE buttons are preprogrammed for use with Onkyo DVD players and CD players respectively.

\* To control another manufacturer's CD recorder or MD recorder, enter the appropriate control code to the [CD] REMOTE MODE button.

### Remote Control Codes for Onkyo Components Connected via RI

Onkyo components that are connected via **RI** are controlled by pointing the remote controller at the AV receiver, not the component. This allows you to control components that are out of view, in a rack, for example.

- 1** Make sure the Onkyo component is connected with an **RI** cable and an analog audio cable (RCA).  
See page 38 for details.
- 2** Enter the appropriate remote control code for the **REMOTE MODE** button.
  - [DVD] **REMOTE MODE** button  
**5002:** Onkyo DVD player with **RI**
  - [CD] **REMOTE MODE** button  
**6002:** Onkyo CD player with **RI**
  - [MD] **REMOTE MODE** button  
**6008:** Onkyo MD recorder with **RI**
  - [CDR] **REMOTE MODE** button  
**6006:** Onkyo CD recorder with **RI**

See the previous page for how to enter remote control codes.
- 3** Press the **REMOTE MODE** button, point the remote controller at the AV receiver, and operate the component.

If you want to control an Onkyo component by pointing the remote controller directly at it, or you want to control an Onkyo component that's not connected via **RI**, use the following remote control codes:

- [DVD] **REMOTE MODE** button  
**5001:** Onkyo DVD player without **RI** (default)
- [CD] **REMOTE MODE** button  
**6001:** Onkyo CD player without **RI** (default)
- [MD] **REMOTE MODE** button  
**6007:** Onkyo MD recorder without **RI**
- [CDR] **REMOTE MODE** button  
**6005:** Onkyo CD recorder without **RI**

#### Note:

If you connect an **RI**-capable Onkyo MiniDisc or CD recorder to the TAPE IN/OUT jacks, for remote operation to work properly, you must set the Input Display to MD or CDR (see page 46).

### Resetting the REMOTE MODE Buttons

You can reset a **REMOTE MODE** button to its default remote control code.

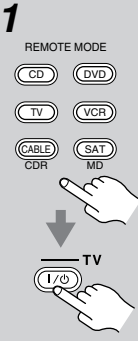
- 1**

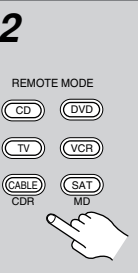
**While holding down the **REMOTE MODE** button that you want to reset, press the **TV** [I/⏻] button.**  
The Remote indicator flashes three times.
- 2**



**Press the **REMOTE MODE** button again.**  
The Remote indicator flashes twice, indicating that the button has been reset.

The [DVD] and [CD] **REMOTE MODE** buttons are preprogrammed with remote control codes for controlling Onkyo DVD players and CD players respectively. When these buttons are reset, the preprogrammed code is restored.

### Resetting the Remote Controller

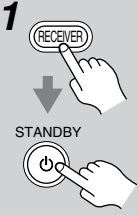
You can reset the remote controller to its default settings.

- 1**

**While holding down the [RECEIVER] **REMOTE MODE** button, press the [STANDBY] button.**  
The Remote indicator flashes five times.
- 2**

**Press the [RECEIVER] **REMOTE MODE** button again.**  
The Remote indicator flashes twice, indicating that the remote controller has been reset.

## Controlling Other Components—Continued

To control another component, point the remote controller at it and use the buttons explained below. (You must select the appropriate remote control mode first.) With some AV components, certain buttons may not work as expected, and some may not work at all.

### ■ Controlling a TV

Press [TV] first

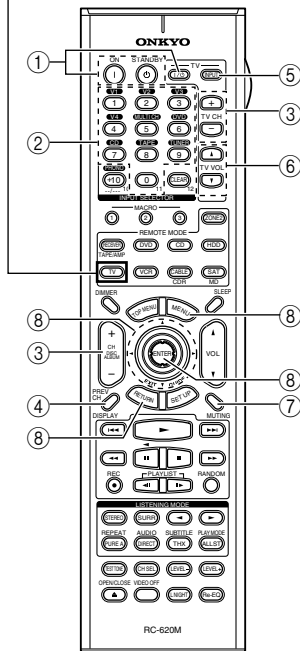

- ① [ON], [STANDBY], TV [⏻/⏪]\*  
Set the TV to On or Standby.
- ② **Number buttons**  
Enter numbers.
- ③ [CH +/-], TV CH [+]/[-]\*  
Select channels on the TV.
- ④ [PREV CH]  
Selects the previous channel.
- ⑤ [TV INPUT]\*  
Selects the TV's external inputs.
- ⑥ TV VOL [▲]/[▼]\*  
Adjust the TV's volume.
- ⑦ [MUTING]  
Mutes the TV.
- ⑧ [▲]/[▼]/[◀]/[▶]/[MENU]/  
[ENTER]/[RETURN]  
Navigate menus on the TV.

\* Buttons marked with an asterisk (\*) are exclusively for controlling a TV and can be used at any-time regardless of the current remote controller mode.

### ■ Controlling a VCR

Press [VCR] first

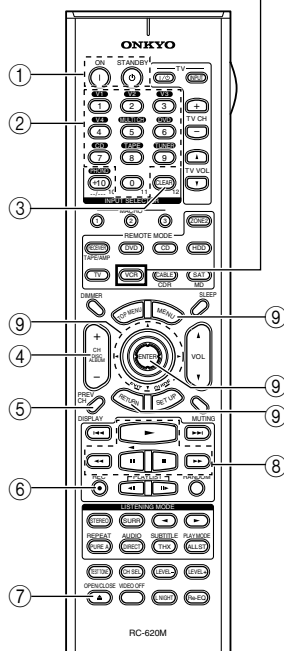

- ① [ON], [STANDBY]  
Set the VCR to On or Standby.
- ② **Number buttons**  
Enter numbers.
- ③ [CLEAR]  
Cancels functions.
- ④ [CH +/-]  
Selects channels on the VCR.
- ⑤ [PREV CH]  
Selects the previous channel.
- ⑥ REC [●]  
Starts recording.
- ⑦ Eject [▲]  
Ejects the videocassette.
- ⑧ [▶], [⏸], [■], [◀], [▶]  
Play, Pause, Stop, Rewind, and Fast forward.
- ⑨ [▲]/[▼]/[◀]/[▶]/[MENU]/  
[ENTER]/[RETURN]  
Navigate menus on the VCR.

### ■ Controlling a Satellite or Cable Receiver

Press [SAT] or [CABLE] first

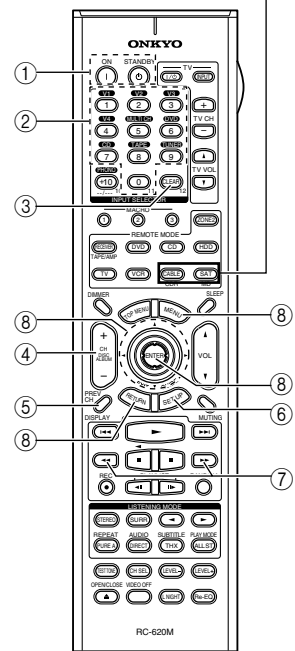

- ① [ON], [STANDBY]  
Set the satellite/cable receiver to On or Standby.
- ② **Number buttons**  
Enter numbers.
- ③ [CLEAR]  
Cancels functions.
- ④ [CH +/-]  
Selects satellite/cable channels.
- ⑤ [PREV CH]  
Selects the previous channel.
- ⑥ [GUIDE]  
Displays the program guide.
- ⑦ [◀], [▶]  
Rewind and Fast forward.
- ⑧ [▲]/[▼]/[◀]/[▶]/[MENU]/  
[ENTER]/[RETURN]  
Navigate menus on the satellite/cable receiver.



## Learning Commands from Other Remote Controllers

The AV receiver's remote controller can receive and learn commands from other remote controllers. By transmitting, for example, the Play command from your CD player's remote controller, the remote controller can learn it and then transmit the exact same command when its Play [▶] button is pressed in the CD remote mode. You can also use this function to learn individual commands after entering a remote control code (page 86).

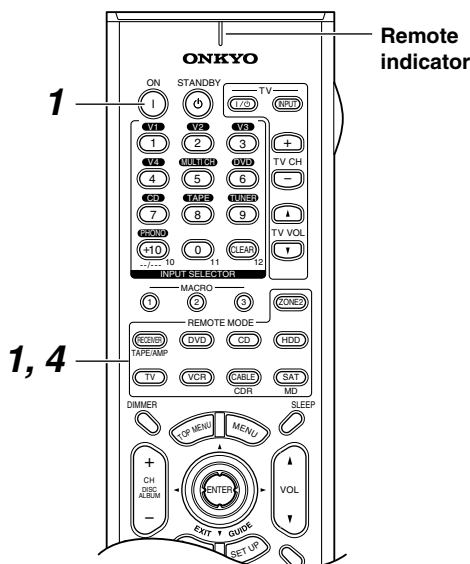

**1** While holding down the **REMOTE MODE** button for the mode in which you want to use the command, press the **[ON]** button.

The Remote indicator lights up.

**2** On this AV receiver's remote controller, press the button you want to learn the new command.

**3** Point the remote controllers at each other, about 2 to 6 inches (5–15 cm) apart, and then press and hold the button whose command you want to learn until the Remote indicator flashes.

If the command is learned successfully, the Remote indicator flashes twice.

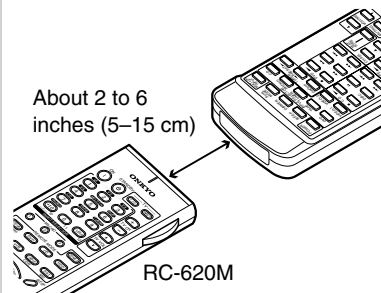

**4** To learn more commands, repeat steps 2 and 3.

Press any REMOTE MODE button when you've finished.

### Notes:

- The following buttons cannot learn new commands: REMOTE MODE, MACRO [1], [2], [3], TV [1/⏻], TV [INPUT], TV CH [+]/[-], TV VOL [▲]/[▼], Light.
- The remote controller can learn approximately 70-90 commands, although, this will be reduced by commands that use a lot of memory.
- Remote controller buttons such as Play, Stop, Pause, and so on are preprogrammed with commands for controlling Onkyo CD players, cassette decks, and DVD players. However, they can learn new commands, and you can restore the preprogrammed commands by resetting the remote controller (see page 87).
- To overwrite a previously learned command, repeat this procedure.
- Only commands from infrared remote controllers can be learned.
- When the remote controller's batteries expire, all learned commands will be lost and will have to be learned all over again, so don't discard your other remote controllers.

## Using Macros

You can program the remote controller's MACRO buttons to perform a sequence of actions.

### Example:

To play a CD, you typically need to perform the following actions:

1. Press the [RECEIVER] REMOTE MODE button to select the Receiver remote controller mode.
2. Press the [ON] button to turn on the AV receiver.
3. Press the [CD] INPUT SELECTOR button to select the CD input source.
4. Press the [CD] REMOTE MODE button to select the CD remote controller mode.
5. Press the Play [▶] button to start playback on the CD player.

You can program a MACRO button so that all five actions are performed with just one button press.

## Making Macros

You can make one macro for each MACRO button, and each macro may contain up to eight commands.

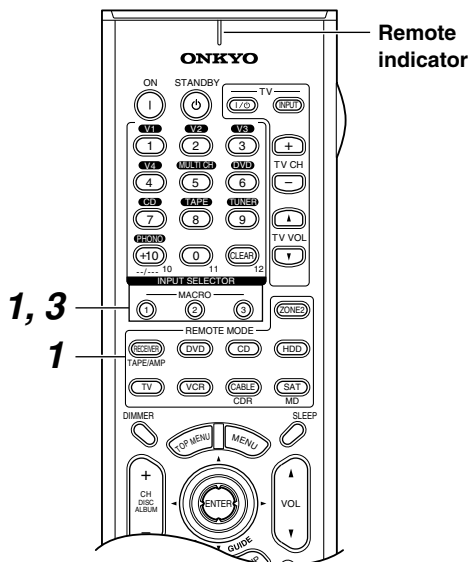

### 1

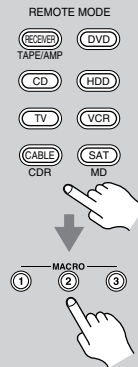

While holding down the **REMOTE MODE** button for the mode you want to start with, press **MACRO** button [1], [2], or [3].

The Remote indicator lights up.

For the CD example in the left column, you'd press and hold the [RECEIVER] REMOTE MODE button, and then press MACRO button [1], [2], or [3].

### 2

On the remote controller, press the buttons whose actions you want to program into the macro in the order you want them performed.

For the CD example in the left column, you'd press the following buttons: [ON], INPUT SELECTOR [CD], REMOTE MODE [CD], Play [▶].

### 3

When you've finished, press the **MACRO** button again.

The Remote indicator flashes twice.

If you enter eight commands, the process will finish automatically.

### Note:

- If one or more of the buttons you used to make a macro are taught new commands, the macro will no longer work properly and will have to be made again.

## Running Macros

### 1

Press the **MACRO** [1], [2], or [3] button.

The commands in the macro are transmitted in the order in which they were programmed. Keep the remote controller pointed at the AV receiver until all of the commands have been transmitted.

Macros can be run at anytime regardless of the current remote controller mode.

## Deleting Macros

### 1

While holding down the [RECEIVER] REMOTE MODE button, press the **MACRO** button whose macro you want to delete.

### 2

Press the **MACRO** button again.

# Troubleshooting

If you have any trouble using the AV receiver, look for a solution in this section. If you can't resolve the issue yourself, contact your Onkyo dealer.

## Power

### Can't turn on the AV receiver

- Make sure that the power cord is plugged into the wall outlet properly.
- Unplug the power cord from the wall outlet, wait 5 seconds or more, then plug it in again.

### The AV receiver turns off as soon as it's turned on

- The amp protection circuit has been activated. Remove the power cord from the wall outlet immediately. Disconnect all speaker cables and input sources, and leave the AV receiver with its power cord disconnected for 1 hour. After that, reconnect the power cord and set the volume to maximum. If the AV receiver stays on, set the volume to minimum, disconnect the power cord, and reconnect your speakers and input sources. If the AV receiver turns off when you set the volume to maximum, disconnect the power cord, and contact your Onkyo dealer.

## Audio

### There's no sound or it's very quiet

- Make sure that the digital input source is selected properly (page 45).
- Make sure that all audio connecting plugs are pushed in all the way (page 24).
- Make sure that the polarity of the speaker cables is correct, and that the bare wire is in contact with metal part of each speaker terminal (page 21)
- Make sure that the speaker cables are not shorting.
- Check the volume (page 48). The AV receiver is designed for home theater enjoyment and has a wide volume range for precise adjustment.
- If the MUTING indicator is shown on the display, press the remote controller's [MUTING] button to unmute the AV receiver (page 58).
- While a pair of headphones is connected to the PHONES jack, no sound is output by the speakers (page 59).
- Check the digital audio output settings on the connected device. On some games consoles, such as those that can play DVDs, the default setting is off.
- With some DVD-Video discs, you need to select an audio format from a menu.
- If your turntable uses an MC cartridge, you must connect an MC head amp, or an MC transformer (page 35).
- Check the speaker settings (pages 70–75).
- The input signal format is set to PCM or DTS. Set it to Auto (page 80).

- If there's no sound from a DVD player connected to an HDMI IN, check the DVD player's output settings, and be sure to select a supported audio format.

### Only the front speakers produce sound

- When the Stereo listening mode is selected, only the front speakers and subwoofer produce sound.
- In the Mono listening mode, only the front speakers output sound when the Output Sp setting is set to Front (page 68).
- Make sure the speakers are configured correctly (pages 70, 71).

### Only the center speaker produces sound

- If you use the Pro Logic IIX Movie or Pro Logic IIX Music listening mode with a mono source, such as an AM radio station or mono TV program, the sound is concentrated in the center speaker.
- In the Mono listening mode, only the center speaker outputs sound when the Output Sp setting is set to Center (page 68).
- Make sure the speakers are configured correctly (pages 70, 71).

### The surround speakers produce no sound

- When the Stereo or Mono listening mode is selected, the surround speakers produce no sound.
- Depending on the source and current listening mode, not much sound may be produced by the surround speakers. Try selecting another listening mode.
- Make sure the speakers are configured correctly (pages 70, 71).

### The center speaker produces no sound

- When the Stereo listening mode is selected, the center speaker produces no sound.
- In the Mono listening mode, only the front speakers output sound when the Output Sp setting is set to Front (page 68).
- Make sure the speakers are configured correctly (pages 70, 71).

### The surround back speakers produce no sound

- The surround back speakers are not used with all listening modes. Select another listening mode (page 60).
- Not much sound may be produced by the surround back speakers with some sources.
- Make sure the speakers are configured correctly (pages 70, 71).
- When the ZONE 2 SPEAKERS terminals are used, playback in the main room is reduced to 5.1-channels, and the surround back speakers produce no sound (page 82).

### The subwoofer produces no sound

- When you play source material that contains no information in the LFE channel, the subwoofer produces no sound.
- Make sure the speakers are configured correctly (pages 70, 71).

### The Zone 2 speakers produce no sound

- The Zone 2 speakers only output sources that are connected to an analog input. Check to see if the source is connected to an analog input.

### There's no sound with a certain signal format

- Check the digital audio output setting on the connected device. On some games consoles, such as those that can play DVDs, the default setting is off.
- With some DVD-Video discs, you need to select an audio output format from a menu.

### Can't get 6.1- or 7.1-channel playback

- When the ZONE 2 SPEAKERS terminals are used, playback in the main room is reduced to 5.1-channels.

### The volume cannot be set to +18 dB (99)

- After the Automatic Speaker Setup function has been used, or the volume level of each speaker has been adjusted (pages 58, 73), the maximum possible volume setting be reduced.

### Noise can be heard

- Using cable ties to bundle audio cables with power cords, speaker cables, and so on may degrade the audio performance, so don't do it.
- An audio cable may be picking up interference. Try repositioning your cables.

### The Late Night function doesn't work

- Make sure the source material is Dolby Digital (page 68).

### The multichannel DVD input doesn't work

- Check the multichannel DVD input connections (page 28).
- To select the multichannel DVD input, press the [MULTI CH] input selector button.
- Check the audio output settings on your DVD player.

### About DTS signals

- When playing DTS program material, using the pause, fast forward, or fast reverse function on your player may produce a short audible noise. This is not a malfunction.
- When DTS program material ends and the DTS bitstream stops, the AV receiver remains in DTS listening mode and the DTS indicator remains on. This is to prevent noise when you use the pause, fast forward, or fast reverse function on your player. If you switch your player from DTS to PCM, because the AV receiver does not switch formats immediately, you may not hear any sound, in which case you should stop your player for about 3 seconds, and then resume playback.

- With some CD players, you won't be able to playback DTS material properly even though your player is connected to a digital input on the AV receiver. This is usually because the DTS bitstream has been processed (e.g., output level, sampling rate, or frequency response changed) and the AV receiver doesn't recognize it as a genuine DTS signal. In such cases, you may hear noise.

### The beginning of audio received by an HDMI IN can't be heard

- Since it takes longer to identify the format of an HDMI signal than it does for other digital audio signals, audio output may not start immediately.

## Video

### There's no picture

- Make sure that all video connecting plugs are pushed in all the way (page 24).
- Make sure that each video component is properly connected.
- If a video component is connected to a component video input, your TV must be connected to the COMPONENT VIDEO OUT or HDMI OUT (page 25).
- If a video component is connected to an HDMI input, your TV must be connected to the HDMI OUT.
- While the Pure Audio listening mode is selected, the video circuitry is turned off and only the HDMI OUT outputs video signals.
- On your TV, make sure that the video input to which the AV receiver is connected is selected.
- To watch a composite video or S-Video source on a TV that's connected to the COMPONENT VIDEO OUT, select "--" in the "Component Video Setup" on page 44.
- To watch a composite video, S-Video, or component video source on a TV that's connected to the HDMI OUT, select "--" in the "HDMI Video Setup" on page 43.

### There's no picture from a source connected to an HDMI IN

- If the message "Resolution Error" appears on the AV receiver's display, this indicates that the TV or display does not support the current video resolution and you need to select another resolution on your DVD player.

### The onscreen menus don't appear

- On your TV, make sure that the video input to which the AV receiver is connected is selected.

### The picture is distorted

- On non-North American models, specify the TV system used in your area in the "TV Format Setup" on page 47.

### The immediate display does not appear

- The immediate display (operation details) may not appear on a TV that's connected to the HDMI OUT or COMPONENT VIDEO OUT.

### Tuner

#### Reception is noisy, stereo FM reception suffers from hiss, or the FM STEREO indicator doesn't appear

- Relocate your antenna.
- Move the AV receiver away from your TV or computer.
- Listen to the station in mono (page 49).
- When listening to an AM station, operating the remote controller may cause noise.
- Passing cars and airplanes can cause interference.
- Concrete walls weaken radio signals.
- If nothing improves the reception, install an outdoor antenna.

#### Can't select XM radio channels (North American model only)

- Channels cannot be selected while the ► ◀ indicator is flashing, as tuning is in progress.

### Remote Controller

#### The remote controller doesn't work

- Make sure that the batteries are installed with the correct polarity (page 13).
- Make sure that the remote controller is not too far away from the AV receiver, and that there's no obstruction between the remote controller and the AV receiver's remote control sensor (page 13).
- Make sure you've selected the correct remote controller mode (page 14).
- Make sure you've entered the correct remote control code (page 86).

#### Can't control other components

- Make sure you've selected the correct remote controller mode (page 14).
- If you've connected an **RI**-capable Onkyo MD recorder, CD recorder, or next generation HDD-compatible component to the TAPE IN/OUT jacks, or a Remote Interactive Dock to the VIDEO 3 IN jacks, for the remote controller to work properly, you must set the Input Display to MD, CDR, or HDD (see page 46).
- The entered remote control code may not be correct. If more than one code is listed, try each one.
- If none of the codes work, use the Learning function to learn the commands of the other component's remote controller (page 89).
- With some AV components, certain buttons may not work as expected, and some may not work at all.
- To control an Onkyo component that's connected via **RI**, point the remote controller at the AV receiver. Be sure to enter the appropriate remote control code first (page 87).
- To control an Onkyo component that's not connected via **RI**, or another manufacturer's component, point

the remote controller at the component. Be sure to enter the appropriate remote control code first (page 86).

#### Can't learn commands from another remote controller

- When learning commands, make sure that the transmitting ends of both remote controllers are pointing at each other.
- Are you trying to learn from a remote controller that cannot be used for learning? Some commands cannot be learned, especially those that contain several instructions.

### Recording

#### Can't record

- On your recorder, make sure the correct input is selected.
- To prevent signal loops and damage to the AV receiver, input signals are not fed through to outputs with the same name (e.g., TAPE IN to TAPE OUT, VIDEO 1 IN to VIDEO 1 OUT, or VIDEO 2 IN to VIDEO 2 OUT).
- When the Pure Audio listening mode is selected, video recording is not possible because no video signals are output. Select another listening mode.

### Others

#### The sound changes when I connect my headphones

- When a pair of headphones is connected, the listening mode is set to Stereo, unless it's already set to Stereo, Mono, Direct, or Pure Audio, in which case it stays the same.

#### How do I change the language of a multiplex source

- Use the "Multiplex" setting on the "Audio Adjust" menus to select "Main" or "Sub" (page 68).

#### The **RI** functions don't work

- To use **RI**, you must make an **RI** connection and an analog audio connection (RCA) between the component and AV receiver, even if they are connected digitally (page 38).
- While Zone 2 is on, the **RI** functions do not work.

#### The AV receiver's display doesn't work

- The display is turned off when the Pure Audio listening mode is selected.

The AV receiver contains a microcomputer for signal processing and control functions. In very rare situations, severe interference, noise from an external source, or static electricity may cause it to lockup. In the unlikely event that this happens, unplug the power cord from the wall outlet, wait at least five seconds, and then plug it back in again.

Onkyo is not responsible for damages (such as CD rental fees) due to unsuccessful recordings caused by the unit's malfunction. Before you record important data, make sure that the material will be recorded correctly.

**To reset the AV receiver to its factory defaults, turn it on and, while holding down the [VIDEO 1] button, press the [STANDBY/ON] button. "Clear" will appear on the display and the AV receiver will enter Standby mode.**

For North American and Australian models, set the AV receiver to Standby before disconnecting the power cord from the wall outlet. For other models, set the AV receiver to Standby and the POWER switch to OFF before disconnect the power cord.

# Specification

## Amplifier Section

### Rated Power Output

North American:

**105 watts minimum continuous power per channel, 8 ohm loads, 2 channels driven from 20 Hz to 20 kHz, with a maximum total harmonic distortion of 0.08% (FTC)**

**135 watts minimum continuous power per channel, 6 ohm loads, 2 channels driven at 1 kHz, with a maximum total harmonic distortion of 0.1% (FTC)**

European:

7 ch × 170 W at 6 ohms, 1 kHz, 1 ch driven (IEC)

Others (Maximum Output Power):

7 ch × 200 W at 6 ohms, 1 kHz, 1 ch driven (JEITA)

|                                 |  |
|---------------------------------|--|
| Dynamic Power                   | 240 W + 240 W (3 Ω, Front)<br>180 W + 180 W (4 Ω, Front)<br>125 W + 125 W (8 Ω, Front) |
| THD (Total Harmonic Distortion) | 0.08% (Power Rated)  |
| Damping Factor                  | 60 (Front, 1 kHz, 8Ω)  |
| Input Sensitivity and Impedance | 200 mV/ 47 kΩ (LINE)<br>2.5 mV/47 kΩ (PHONO MM)  |
| Output Level and Impedance      | 200 mV/ 470 Ω (REC OUT)  |
| Phono Overload                  | 70 mV (MM 1 kHz, 0.5%)   |
| Frequency Response              | 5 Hz–100 kHz/ +1 dB–3 dB (Direct mode)   |
| Tone Control                    | ±10 dB, 50 Hz (BASS)<br>±10 dB, 20 kHz (TREBLE)  |
| Signal to Noise Ratio           | 106 dB (LINE, IHF-A)<br>80 dB (PHONO, IHF-A)   |
| Speaker Impedance               | 4Ω–16Ω or 6Ω–16Ω   |

## Video Section

### Input Sensitivity/Output

|                     |   |
|---------------------|---|
| Level and Impedance | 1 Vp-p /75Ω (Component and S-Video Y)<br>0.7 Vp-p /75Ω (Component Pb/Cb,Pr/Cr)<br>0.28 Vp-p /75Ω (S-Video C)<br>1 Vp-p /75Ω (Composite) |
|---------------------|---|

### Component Video

|                    |               |
|--------------------|---------------|
| Frequency Response | 5 Hz – 50 MHz |
|--------------------|---------------|

## Tuner Section

### FM

|                        |   |
|------------------------|---|
| Tuning Frequency Range | North American: 87.5 MHz– 107.9 MHz<br>Other: 87.5 MHz– 108.0 MHz |
| Usable Sensitivity     | Stereo: 22.2 dBf (IHF)<br>Mono: 15.2 dBf (IHF)                    |
| Signal to Noise Ratio  | Stereo: 67 dB (IHF-A)<br>Mono: 73 dB (IHF-A)                      |
| THD                    | Stereo: 0.5% (1 kHz)<br>Mono: 0.3% (1 kHz)                        |
| Frequency Response     | 30 Hz–15 kHz / ±1 dB  |
| Stereo Separation      | 40 dB (1 kHz)   |

### AM

|                        |  |
|------------------------|--|
| Tuning Frequency Range | North American: 530 kHz–1710 kHz<br>European: 522 kHz–1611 kHz<br>Asian: 530/522 kHz–1710/1611 kHz |
| Usable Sensitivity     | 300 μV/m   |
| Signal to Noise Ratio  | 40 dB  |
| THD                    | 0.70%  |

## General

|                           |  |
|---------------------------|--|
| Power Supply              | North American: AC 120 V, 60 Hz<br>European: AC 230 V, 50 Hz<br>Others: AC 120/220-240 V, 50/60 Hz<br>AC 220-230 V, 50/60 Hz |
| Power Consumption         | North American: 7.5 A<br>European: 810 W<br>Others: 800 W<br>860 W   |
| Standby Power Consumption | North American: 0.2 W<br>Australian and European: 0.2 W<br>Others: 0.6 W   |
| Dimensions (W × H × D)    | 435 × 173.5 × 430 mm<br>17-1/8" × 6-13/16" × 16-15/16"   |
| Weight                    | North American: 13.4 kg<br>29.5 lbs.<br>European: 13.6 kg<br>30.0 lbs.<br>Others: 13.4 kg<br>29.5 lbs.                       |

### Video Inputs

|           |                                     |
|-----------|-------------------------------------|
| HDMI      | IN1, IN2                            |
| Component | IN1, IN2, IN3                       |
| S-Video   | DVD, VIDEO1, VIDEO2, VIDEO3, VIDEO4 |
| Composite | DVD, VIDEO1, VIDEO2, VIDEO3, VIDEO4 |

### Video Outputs

|           |                             |
|-----------|-----------------------------|
| HDMI      | OUT                         |
| Component | OUT                         |
| S-Video   | MONITOR OUT, VIDEO1, VIDEO2 |
| Composite | MONITOR OUT, VIDEO1, VIDEO2 |

### Audio Inputs

|                    |   |
|--------------------|---|
| Digital Inputs     | Optical: 5 (1 on Front Panel)<br>Coaxial: 2                         |
| Analog Inputs      | DVD (MULTICHANNEL), VIDEO1, VIDEO2, VIDEO3, VIDEO4, TAPE, CD, PHONO |
| Multichannel Input | 7.1 ch (DVD)  |

### Audio Outputs

|                          |   |
|--------------------------|---|
| Digital Output           | Optical: 1                                |
| Analog Outputs           | TAPE, VIDEO1, VIDEO2, ZONE2               |
| Multichannel Pre Outputs | 7   |
| Subwoofer Pre Outputs    | 1   |
| Speaker Outputs          | L, R, C, SL, SR, SBL, SBR<br>ZONE2 (L, R) |
| Phones                   | 1   |
| RS232                    | 1   |
| IR Input/Output          | 1/1                                       |
| 12 V Trigger Out         | ZONE2                                     |

Specifications and features are subject to change without notice.

## **ONKYO CORPORATION**

Sales & Product Planning Div. : 2-1, Nisshin-cho, Neyagawa-shi, OSAKA 572-8540, JAPAN  
Tel: 072-831-8023 Fax: 072-831-8124

### **ONKYO U.S.A. CORPORATION**

18 Park Way, Upper Saddle River, N.J. 07458, U.S.A.  
Tel: 201-785-2600 Fax: 201-785-2650 <http://www.us.onkyo.com/>

### **ONKYO EUROPE ELECTRONICS GmbH**

Liegnitzerstrasse 6, 82194 Groebenzell, GERMANY  
Tel: +49-8142-4401-0 Fax: +49-8142-4401-555 <http://www.eu.onkyo.com/>

### **ONKYO EUROPE UK Office**

Suite 1, Gregories Court, Gregories Road, Beaconsfield, Buckinghamshire, HP9 1HQ  
UNITED KINGDOM Tel: +44-(0)1494-681515 Fax: +44(0)-1494-680452

### **ONKYO CHINA LIMITED**

Unit 1&12, 9/F, Ever Gain Plaza Tower 1, 88, Container Port Road, Kwai Chung,  
N.T., HONG KONG Tel: 852-2429-3118 Fax: 852-2428-9039  
<http://www.ch.onkyo.com/>



I0609-2

SN 29344329A

(C) Copyright 2006 ONKYO CORPORATION Japan. All rights reserved.

